

ISDN TK-System

Manual

AC 14 USB

Telephone

Internet connection

And much more



AGFEO
einfach | perfekt | kommunizieren

Table of Contents

- The new kind of operation
- Safety instructions
- Important information for using analog terminals

- Scope of delivery
- Assembly of the telecommunications system
- Terminal connections
- ISDN connection

- Basic functions - "Telephoning", "Answering calls" and "Transferring a call"

Programming with a PC. The configuration program TK-Set is part of the TK-Soft software package.

Remote configuration by the dealer

Programming with a telephone

- Multiple Subscriber Numbers (MSN)

- Software overview
- Program components TK-soft
- Program components TK-com
- CTI computer-assisted telephone calls via TAPI
- System conditions

- Glossary
- When something goes wrong
- Action in the event of faults

- Technical hotline
- Declaration of Conformity

- Pictograms and keys
- The LEDs of the AC 14 USB

- Connecting a printer
- Connecting a power pack
- Commissioning

- Comfort functions of the telephone system in alphabetical order

- Ringing assignments (day, night, internal call forwarding service)
- Authorisations (external authorisation, external access, regional range, barred range)
- Types of terminals

Communication through PC

- Set up USB connection
- Install driver software
- Uninstall driver software
- Install communications software
- Connections to Internet or other network

- Ringing and tones
- Technical data

Introduction

Set up

Operation

Programming

Appendix

Key words

Safety Instructions

The telecommunications system is designed for connection to an ISDN base connection (DSS 1 – multiple connection).

You can connect all analog terminals to the analog subscriber accesses of the telecommunications system which you can also

- The telecommunications system meets the prescribed conformity and safety requirements.
- Pull the power pack out of the mains socket to switch off the telecommunications system before connecting the leads to the subscribers and to the ISDN network. Danger of lethal injury!
- Do not connect or disconnect the leads during a thunderstorm.

operate on the analog telecommunications network.

Any other use of the telecommunications system is contrary to the intended purpose and thus prohibited.

The telecommunications system has the General Connection Licence (AAE).

- Lay the leads so that no-one can step on or trip over them.
- Make sure that no liquids get inside the telecommunications system.
- No liability will be accepted for consequential damage such as costs for an accidentally maintained connection.
- The telecommunications system is out of order during a power cut. You cannot use the phone.

Important information about using analog terminals

You can connect analog **terminals** such as normal telephones (a/b), answering machines, group 2 and 3 fax's and analog modems to the terminals of your telecommunications system.

The **dialling method** of the analog terminal may be dual-tone multi-frequency dialling (DTMF) or pulse dialling (PD). The terminal should be set to DTMF to make optimum use of all functions. The telecommunications system automatically recognises the respective dialling method.

If you have switched on the "External seizure spontaneous with internal" function for your telephone (as-delivered state), you can reach an internal subscriber by dialling the **#** key (hash) and the internal phone number (11, ..., 14). On telephones without a **#** key or which do not support this, e.g. telephones with the pulse dialling method, no internal dialling is possible. You can reach an external subscriber directly by dialling the external phone number.

Your telephone should have a ***** key (asterisk key) for simple operation of the telecommunications system. You can press the numbers **9 9** instead of the ***** key on telephones which have no ***** key or do not support these functions.

Please observe the following instructions: Analog telephones with DTMF require a signal key (refer back key **R**) with flash for the "refer back inquiry".

In this operating manual, the operating steps listed are always for analog telephones with DTMF. You do not need to press a signal key for the refer back inquiry on analog telephones with PD.

The functions of an analog telephone (e.g. dialling repetition, short dialling) can also be used in connection with your telecommunications system. Please see the operating manual of the telephone concerned for operation of these functions.

Please pay attention to the acoustic signals of your telecommunications system during operation. You will hear the acknowledgement tone when you have successfully completed a * procedure. Otherwise you will hear the error tone (busy tone).

On analog telephones with caller number displays, the telecommunications system transmits the phone number (CLIP function) providing the caller has sent it.









For **modem operation** (transmission speed up to 56600 bps, can be reduced if necessary to 33600 bps by transmission paths and lines) it is recommended to set the port to "External seizure spontaneous" with the PC configurator. Otherwise it is absolutely essential to configure the modem to blind dialling because most modems are unable to recognise the dialling tone of a telecommunications system. Blind dialling is set with the help of the X0 ... X4 parameters for modems which operate with the Hayes command set.

Pictograms and Keys





Operation of every function of the telecommunications system is explained clearly

and comprehensibly by pictograms.

Pictograms

	Acoustic call signal (tone call)		Make call
	Lift handset		Replace handset
	Enter phone numbers, code numbers (PIN)		Conference
	Tones audible in the handset, e.g. acknowledgement tone		Room monitoring by telephone

Keys

	Refer back key (signal key, flash key) for referring back during a call		Asterisk key for starting certain functions (* procedures)
	Number keys for entering phone numbers, e.g. "9" or letters "X" (Vanity dialling)		Hash key for internal dialling for spontaneous line seizure, terminating an input

The LEDs of the AC 14 USB

Green LED – The function LED

- lights steadily when the telecommunications system is in operation
- flashes slowly when a diversion to an external subscriber is set up through the telecommunications system or in the ISDN exchange.
- Flashes rapidly when an entry is available in the telecommunication system's call list (this indication has priority over a diversion)

Red LED – The busy LED

- flashes slowly when a line (a B-channel) is busy
- lights steadily when both lines (both B-channels) are busy

Set up

Scope of delivery

- 1 ISDN telecommunications system
- 2 plugs and screws
- 2 screw terminals 4-pole
- 1 ISDN connecting cable
- 1 PC connecting cable
- 1 230 V power pack
- 1 operating manual
- 1 CD-ROM with TK-Soft (TK-Set, TK-LCR, TK-Bill and TK-Phone) and TK-Com (TK-Tel, TK-Voice, TK-File, TK-Fax)

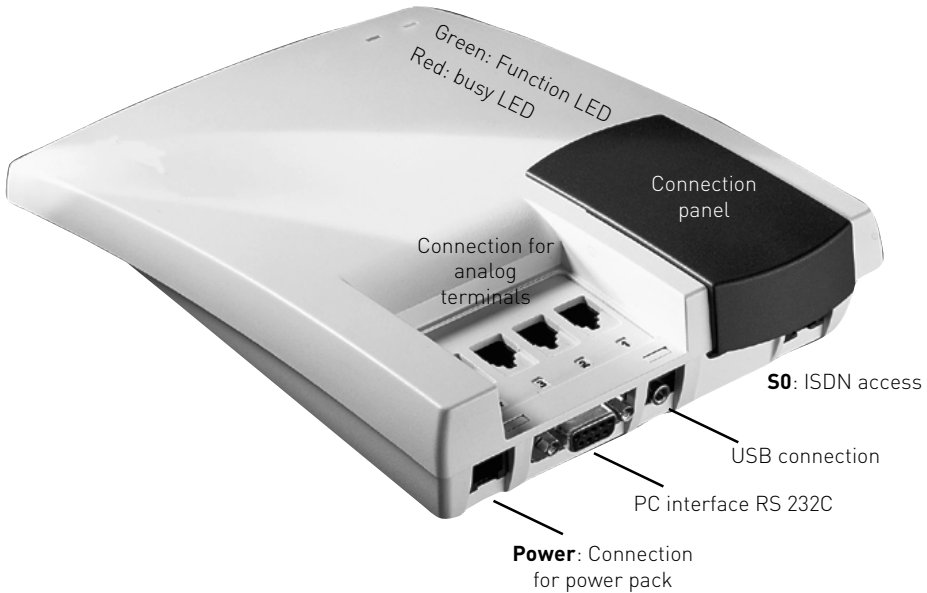

Fig. 1: Connections of the telecommunications system

Choosing the location

The telecommunications system is suitable for operation on a desk top or for wall mounting.

Only install the telecommunications system in a dry room where there is no risk of explosions.

- Ambient temperature: 5°C to 40°C
- Humidity: max. 70 % (no condensation)

It may **not** be installed:

- in the vicinity of air conditioning systems, heaters
- where it may be exposed to direct sunlight
- in the vicinity of equipment with illegal interference radiation
- in an excessively dusty environment
- in places where it may be splashed by liquids

230 V mains power supply

The telecommunication system does not work when the 230 V mains voltage fails.

Only use the power pack model no.: TST 53328 provided.

Connectable terminals

You can connect four analog terminals to the telecommunications system. You can connect all analog terminals which you can operate on the public telecommunications network.

Possible analog terminal types are:

- Telephones (a/b telephones)
- Fax machines group 3
- Answering machines
- Modems (up to 56600 bps, transmission can be reduced to 33600 bps if necessary by transmission paths and lines)

On analog telephones which display the caller number the TK-system shows the number (CLIP function) provided this is transmitted by the caller.

For optimum use of all functions, the terminals should be set to dual-tone multi-frequency dialling (DTMF) and have a flash, ***** and **#** key. The telecommunication system detects a flash time of 50 – 600 ms in its as-delivered state.

You can also connect terminals with pulse dialling (PD). The telecommunications system automatically recognises the dialling method. Dial a number greater than 1 on a terminal with PD after connection. Please see the telephone documentation for switching the dialling method and setting the flash time of the telephones.

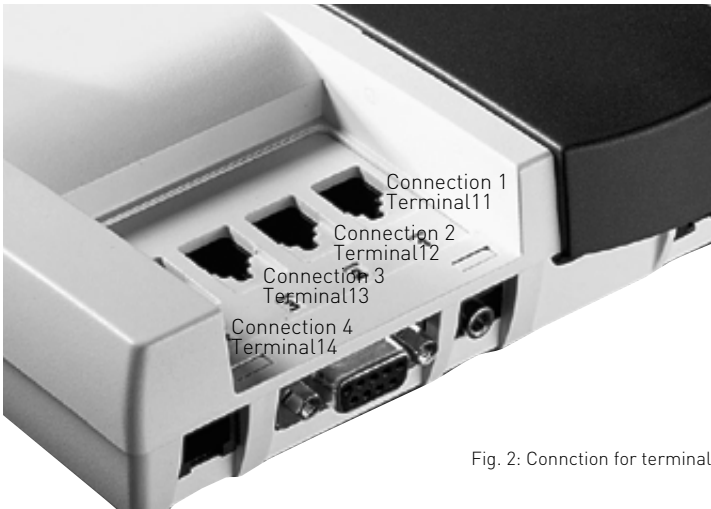

Fig. 2: Conncetion for terminals

Notes on the ISDN access (S0)

The telecommunications system is designed for connecting to an ISDN basic access (multi-equipment access). You can also operate other ISDN terminals at this access, e.g. your PC with ISDN card, an ISDN telephone and more.

The multi-equipment access may be designed as an ISDN bus which is connected to the NTBA. Up to 12 ISDN sockets (IAE or UAE) may belong to this bus. You can connect up to seven other ISDN terminals to the ISDN bus in addition to your ISDN telecommunications system.

Wall mounting

- Mark two vertical drill holes 125 mm apart on the wall.
- When marking the drill holes, make sure that there are no concealed lines at these points (gas, water pipes, electric cables or similar).
- Drill the two holes.
- Mark two vertical drill holes 125 mm apart on the wall.
- When marking the drill holes, make sure that there are no concealed lines at these points (gas, water pipes, electric cables or similar).
- Drill the two holes.
- Hammer in the plugs flush with the wall.
- Screw in the two screws leaving the head protruding by about 4 mm.
- Hang the telecommunications system on the screws and pull it down on the wall until it snaps into place.

Ready to start in seconds

- Plug the Western plug of the power pack into the socket marked "Power" until it snaps in audibly
- Plug one of the Western plugs of the ISDN connecting cable into the socket marked "SO" until it snaps in audibly
- Plug the other Western plug of the ISDN connecting cable into the NTBA (NT) or an installed ISDN socket
- Plug the Western plugs of your terminal into the Western sockets of the telecommunications system
- Plug the power pack into a 230 V socket. The green LED lights up.
- You can now use the phone. After lifting the handset you will hear the external dialling tone and can call any external subscriber.
- The internal phone numbers 11, 12 and 13 are called when one of your phone numbers (MSN) is called.

In the **as-delivered state**, the connections 1 and 2 are set to telephone, connection 3 to answering machine and connection 4 to combi-
port, e.g. for fax.











To enter your multiple subscriber numbers (MSN's), change the ringing assignment and set other functions, please read the chapter "Programming".







Quick entry of multiple subscriber numbers

You can enter multiple subscriber numbers (MSN's) under which you can be reached in the telecommunications system uncomplicatedly and quickly. Enter the MSN with this function at every connection and the corresponding terminal is entered in the ringing assignment for this MSN.

Example: Enter your phone number (345678) at connections 1, 2 and 3. At connection 4 the number of your fax (345677). Callers then reach your telephones and answering machine when they call 345678. The fax is reached under 345677. See the "Programming Instructions" for further information.

Start programming mode:      (system -PIN)  
PRO

										
Lift handset	MSN quick save			MSN-ID		Enter multiple subscriber number (MSN)	Acknowledgement tone	Replace handset		

Exit programming mode:       
END

Connecting terminals to separate TAE sockets

If you want to connect your terminals to separate Western sockets, you will find the connection panel for the plug-in terminals underneath the blue cover.

Unplug the power pack from the 230 V mains socket before removing the cover from and working on the connection panel. Replace the cover before plugging the power pack back into the mains socket.

To open the connection panel, reach underneath the blue cover on the connection side of the telecommunications system and pull the cover down sharply.



Fig. 3: Pulling off the cover

The assignment of the terminal connections is displayed on the connection panel.

To ensure perfect functioning of the telecommunications system and the connected terminals, you should connect the terminals either to the Western sockets or the plug-in terminals! This means that if a terminal is connected directly via a Western socket, e.g. connection 1, no second device should be connected via the terminals at the same terminal connection, e.g. La1/Lb1.



Fig. 4: Open connection panel

The connections La and Lb of the plug-in terminals are connected with connections 1 and 2 of the separate Western sockets.

You can use commercially available telephone lines for the connection.

We recommend: telephone lines J-Y (St) Y
Length between telecommunications system and sockets: max. 800 metres at 0.6 mm wire diameter.

To close the connection panel, place the cover flat on the guides. Push the cover up sharply until it snaps audibly into place.

USB interface (Universal Serial Bus)

You can connect a PC with USB interface to the USB interface of the TK system. The TK system connects the PC easily and quickly with the ISDN. It is not necessary to install an ISDN card in the PC.

Via the USB interface you can configure the TK system with the PC, read off call data and TK-

Phone and use the TAPI interface. You will also have a high-performance universal communications programme available to you through the communication software.

In chapter C "Communication through PC" you find out how to connect the PC to the TK system via USB interface and how to install the communication software.

PC interface

The PC interface of the telecommunications system is a serial RS 232C interface. Here you can connect:

- a PC, for configuring the telecommunications system, for call data evaluation and computer-aided telephony (CTI). The PC connecting cable is contained in the scope of delivery.

Telephoning

With your telecommunications system you can make free calls between the connected terminals and external calls to any external subscribers.

Telephoning externally

For an external call, the telecommunications system seizes one of the two B-channels (lines) of the ISDN access.

In the as-delivered state, the external seizure "spontaneous with internal" is set for every connection.







This means that you immediately hear the external dialling tone when you lift handset. You can dial the desired phone number immediately.

Telephoning internally

You can reach the internal subscribers of your telecommunications system with the internal phone numbers 11 (connection 1), 12 (connection 2), 13 (connection 3) and 14 (connection 4).

With the "external seizure spontaneous with internal" you can reach the internal subscribers by pre-dialling **#**.

Telephoning – "External seizure spontaneous with internal" (as-delivered state)

Call externally						
	Lift the handset	External dialling tone	Enter external phone number	Ringing tone, subscriber is called	Subscriber answers, conversation	End call, replace handset

The spontaneous external seizure (seize outside line) is only possible directly after lifting the handset. If you want to call an external subscriber in refer back mode, you have to seize an outside line (B-channel) with "**0**".

also transmitted to a called ISDN subscriber providing transmission of your phone number is released.

How to account the connection costs under another MSN is described in "External seizure with specific MSN".









Transmitting your phone number - Bei der Externbelegung wird die Ihnen zugeordnete In the case of external seizure the multiple subscriber number (MSN) of the telecommunications system which you are assigned is transmitted to the ISDN exchange. The connection costs are saved there under this phone number. This phone number is

Combi-device connection: A terminal at a connection set as a combi-device (connection 4 in the as-delivered state) sends the Telephone service.

Call internally							
	Lift the handset	External dialling tone	Press the hash key	Internal dialling tone	Enter the internal phone no.	Ringing tone, subscriber is called	Subscriber answers, hold conversation

Switching the external seizure







You can switch off "External seizure spontaneous with internal" and must then select **0** for external connection.

						Off		
Lift handset	EXT ernal seizure spontaneous with internal			Selection		On	Acknowledgement tone	Replace handset

A further variation of the external seizure can only be set with the PC configurator. With the "External seizure spontaneous", the telecommunications system seizes a B-channel as

soon as the handset is lifted. Internal calls and procedures are not possible. It is suitable for terminals which only operate external connections, e.g. fax or modem. *

Telephoning- "External seizure spontaneous with internal" off







Tele- phoning externally							
	Lift handset Internal dialling tone	External seizure with "0"	External dialling tone	Enter external phone no.	Ringing tone, subscriber is called	Subscriber answers, hold conversation	

External seizure at combi-device connection - After dialling the code "10" at the combi-device connection (instead of "0") the telecommunications system also seizes a line. However, it identifies the connection with the Fax service. When seizing with "0", the identification is Telephony service.

number (MSN) of the telecommunications system which you are assigned is transmitted to the ISDN exchange. The connection costs are saved there under this phone number. This phone number is also transmitted to a called ISDN subscriber providing transmission of your phone number is released.

Transmitting your phone number - Bei der Externbelegung wird die Ihnen zugeordnete In the case of external seizure the multiple subscriber





How to account the connection costs under another MSN is described in "External seizure with specific MSN".

Tele- phoning internally						
	Lift handset Internal dialling tone	Enter internal phone number	Ringing tone, subscriber is called	Subscriber answers, hold conversation	End conversation, replace handset	

External seizure with specific MSN

When you have switched off "external seizure spontaneous with internal", you can select a specific MSN different to the one assigned when

dialling externally. This separates the charges, for example for private and business calls

									
Lift handset	Seize MSN	MSN ID	Enter MSN	Terminate input	Enter external phone no.	Hold conversation			

Reserving a line

If you hear the busy tone after external seizure (e.g. with "0") both lines (B-channels) are busy. The red LED lights up. Reserve a line. As soon as a line is free, the telecommunications system

calls you. After lifting the handset you hear the external dialling tone and can enter the external phone number.

									
Lift handset	External seizure, e.g. "0", busy tone, no line free	RES erve a line	Acknowledgement tone	Replace handset					

Notes

External authorisation (Authorisation) -

If you hear the error tone instead of the external dialling tone when seizing an external line, your telephone is not authorised to dial an external phone number.

Barred range - If the barred range of the telecommunications system is programmed for your telephone, you cannot dial the external phone numbers in the barred range. You hear the error tone.

Call internally - possible on telephones with spontaneous external seizure which have no **#** key (hash) or do not support it.

DTMF post-dialling is possible for all existing connections and during a three-party conference. You can post-dial numbers and letters (**1...0**, ***** and **#**).

Reserved line - The telecommunications system calls you for 60 seconds when the reserved line is free. The reservation is cancelled after 1 minute if no connection is made in the meantime.

On telephones without a ***** key (asterisk key) or which do not support it, you have to press the number **9|9** instead of the ***** key.

Answering calls

You can distinguish internal from external calls by different ringing rhythms on your telephone providing your terminal supports different ringing rhythms.

You are connected with the caller when your telephone rings and you lift handset.

Knocking - You receive a call while you are speaking. The call knocks. You hear the internal

knocking tone once (internal call) or the external knocking tones several times (external call). You can answer the call and switch back and forth between the two calls (brokerage).

You can reject the external knocking call. If you reject it, the caller hears the busy tone if only your telephone is being called. If several telephones are being called (see call allocation) only the party with a call waiting will be disconnected.

You are called



Your telephone rings



Lift handset



Hold conversation

The knocking tone sounds - accept call (1st option)



You are holding a conversation and hear the external or internal knocking tone



Replace the handset



Automatic call from knocking party



Lift handset



Hold conversation

The knocking tone sounds - accept call (2nd option)



You are holding a conversation and hear the external or internal knocking tone



Refer back, call is held



Pick up the external call



Hold conversation

Reject external knocking



You are holding a conversation and hear the external knocking tones

Refer back, call is held

Reject the knocking call

Continue speaking

Notes

Both parties hear the knocking tone. You hear the error tone when picking up a knocking call

- if the other party is the desired one in the case of internal knocking
- if both lines are busy in the case of external knocking. You have to end the first conversation

before you can speak to the knocking party (Replace handset or hold the first call with refer back).

You can prevent knocking by activating the knocking prevention function.

Knocking prevention

If you do not want internal or external subscribers to knock, activate the knocking prevention for your

telephone. **As-delivered state:** knocking prevention off.



On



Off

Lift handset

Knocking prevention

Selection

Acknowledgement tone

Replace handset

Transferring a call

You can transfer an external call to another internal subscriber or external subscriber. Two kinds of internal transfer are possible.

Internal transfer with announcement

You call the internal subscriber in refer back, announce the call and Replace handset. You have then transferred the call.

Transfer internally without announcement

You call the internal subscriber in refer back and

Replace handset without speaking to the internal subscriber. The internal subscriber receives a call. He is connected with the caller when he lifts his handset.

In the case of **external transfer**, only transfer with announcement is possible. You call the external subscriber in refer back and announce the other external call. You transfer the call by dialling the code.

Internal transfer with announcement



Hold external conversation



Refer back, external call held



Enter internal phone no.



Announce external call



Transfer external call

Internal transfer without announcement



Hold external conversation



Refer back, external call is held



Enter internal phone no.



Transfer external call

External transfer



Holding 1st external conversation



Refer back, 1st external call is held



Seize line



Enter external phone no.



Hold 2nd external conversation



Refer back, 2nd external call is held



Transfer external call



Replace handset

Notes

You must always seize the line with "0" for **external transfer**. Even when "External seizure spontaneous with internal" is switched on in the telephone.

You bear the costs of the externally transferred call.

Internal transfer with announcement

If the internal subscriber does not answer or is busy you are re-connected with the external subscriber after . You can transfer him to another internal subscriber if necessary.

During refer back, the held external subscriber hears a melody when "Music on Hold" (MoH) is switched on internally or piped in externally.

After an **internal transfer without announcement you are called back** after 45 seconds if the internal subscriber has not answered the transferred call within this time. You are recalled immediately when the internal subscriber is busy.

If you answer the callback you will be re-connected with the external caller. If not, the call is disconnected after 60 seconds.

Automatic dialling - Connect without dialling

You can switch on the "Automatic Dialling" on your telephone for emergencies. If you Lift handset and do not press any key, the telecommunications system automatically dials a

stored external phone number after 10 seconds. Before this, you can dial any phone number normally. Automatic dialling is not activated. **As-delivered state:** Automatic dialling off

Switching automatic dialling on/off

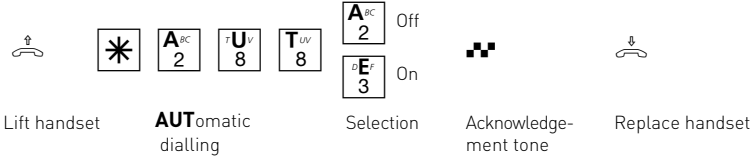

Automatic dialling - Entering/deleting a phone number

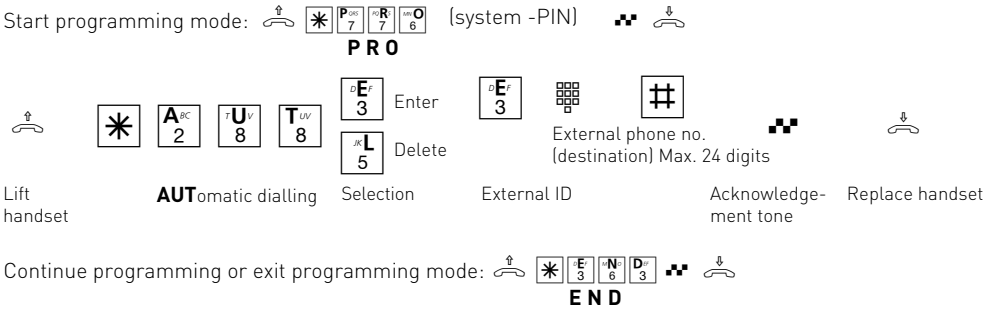

Notes

Check the automatic dialling after programming the external phone numbers. Switch on the automatic dialling, Lift handset, wait for dialling of the external phone number and check that the connection is correct. If the called subscriber is busy, the telecommunications system tries to dial the external phone number again every 10 seconds.

After 12 attempts it automatically aborts automatic dialling. If you hear the error tone when switching on "Automatic dialling", no phone number is programmed. If "Automatic dialling" is switched on, you hear the special dialling tone after lifting the handset.











Busy on Busy

A caller receives no busy tone as long as one of the two B-channels of your ISDN access is free. You hear the knocking tone during the current conversation or other telephones ring. The "Busy on Busy" function prevents this. The caller hears the busy tone if a subscriber of the ringing assignment is busy.

He then knows that you are in but are telephoning at the moment.

"Busy on Busy" can be switched on or off for every multiple subscriber number (MSN) of your telecommunications system.

As-delivered state: off for all MSN's

						On			Enter MSN for which Busy on Busy is to be switched on/off			
Lift handset	BUSy on Busy				Selection		Selection: Busy on Busy on/off For single MSN For All MSNs of your telecommunications system			Acknowledgement tone	Replace handset	

Notes









An ISDN terminal connected parallel to the multi-equipment access and to which the same multiple subscriber number (MSN) as the telecommunications system is assigned, is always called

irrespectively of whether "Busy on Busy" is switched on or off for this MSN in the telecommunications system. The caller hears the ringing tone.

Tracing – Identifying malicious callers

The "Malicious call tracing" feature can only be used by special order from your network provider providing he offers this service.

The ISDN exchange saves the caller's number, your phone number, the date and time of the call. You can have the caller identified during a call or after the caller replaced the receiver, but before you replaced it.

							
Holding external conversation	Refer back	Trace			Acknowledgement tone	Replace handset	

Notes

You can continue the conversation after

    .

Until you continue or terminate the conversation with the caller, the caller hears a melody if "Music on Hold" (MoH) is switched on or piped in externally in the telecommunications system.

You hear the error tone:

- if it is not possible to trace malicious callers
- if the caller can no longer be identified by the exchange

Remote control (switch box)

Some functions of the telecommunications system can be controlled remotely by making a telephone call en route.

The following functions can be controlled remotely:

- release the telecommunications system for remote maintenance and configuration of your telecommunications system
- fix a cost limit for an internal subscriber of the telecommunications system
- switch night service on/off
- switch timer on/off
- switch diversions on/off
- switch internal transfer on/off
- room monitoring

Operating steps for remote control:

- call the switch box of your telecommunications system with the multiple subscriber number (MSN) of the switch box.
- After 2 or 3 rings you will hear the internal music on hold (MoH) of your telecommunications system for 5 seconds.
- Wait until the music finishes.
- Enter the box PIN of the switch box as DTMF characters with a DTMF transmitter or DTMF telephone within 15 seconds otherwise the telecommunications system will disconnect the call. If you enter the correct box PIN you will hear the internal music on hold for another 5 seconds.
- Wait until the music finishes.
- You have prepared for remote control with the switch box. Now enter the  procedure of the desired function from an internal telephone of your telecommunications system.

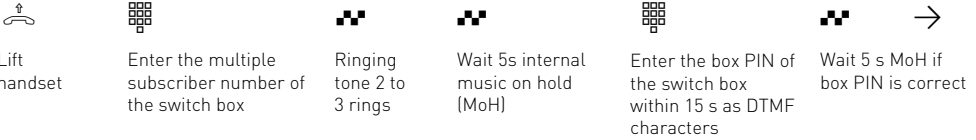

- Enter procedure of the desired function. Example: Night service

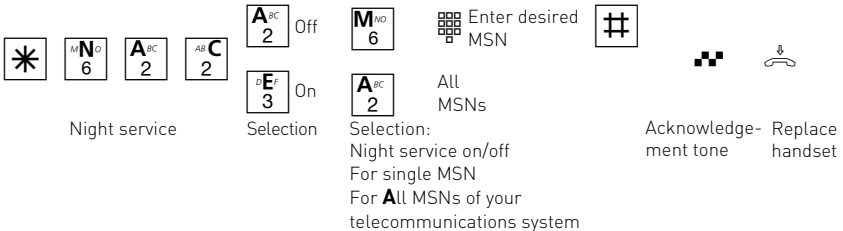

Notes

The entered function becomes active with the acknowledgement tone at the end of the procedure. You can enter the next  procedure if necessary. You break your connection to the switch box by replacing the handset.

The telecommunication breaks the connection every time the wrong box PIN is entered. After three wrong attempts, the switch box is locked for 30 minutes.

Your switch box – Saver number

For mobiles without contractual conditions it is normal to have graduated call charges with one particularly cheap call number. You can have this number as a Saver number in your TK system. To do so indicate the MSN which you have allocated to your switchbox as the cheapest number.

When you call your saver number from your mobile you can onward dial your TK system via the phone book. The TK system will connect you via the 2.B channel (line) at the cheapest fixed network tariff.

It is an advantage if you have stored your mobile number in your TK system memory. If the switchbox identifies your mobile number when you call you can use the phone book in your TK system and be connected immediately after the acknowledgement tone.

If your mobile number is not in the memory you must select access to the switchbox as described under "remote control (switchbox)".

Once you have obtained internal access to the TK system via the switchbox you can use any remote-control function using the appropriate ***** procedure.

Enter/delete mobile number

Start programming mode: ***** **P**₇ **R**₇ **O**₆ (system -PIN)

PRO

	*	H ₄	A ₂	N ₆	E ₃ Enter	E ₃		#		
Lift handset	Mobilnumber				Selection	Enter external code and number			Acknowledge-ment tone	Replace handset

Continue programming or end programming mode: ***** **E**₃ **N**₆ **D**₃

END

Callthrough one the move

			*	T ₈	E ₃	L ₅	K ₅	Short dial index		
Lift handset	Enter switchbox call number (Your saver number)	Acknowledge-ment tone from TK system when mobile number is identified	Phonebook	Enter short dial number 000 to 199 or V anity (names)	Long tone when name has been clearly identified. The number is automatically dialled after 4 seconds or immediately after # .	FDialling tone, subscriber is called, subscriber lifts handset. Talk.				

Notes











If you hear the engaged tone instead of the dialling tone either the subscriber or the 2.B-channel (line) is engaged. After approx. 10

seconds the engaged tone ceases and you can redial an entry in the phone book from ***** **T**₈ **E**₃ **L**₅.

Follow me (Diversion from)

You can divert all calls for other telephones which may not be manned to your own telephone.

You can still telephone normally with the diverted telephone. On lifting the handset, the special dialling tone reminds you that the follow me function is activated.

						Off				
Lift handset	FOL low me				Selection	Internal ID	Enter internal phone no. from which you want to divert calls	Acknowledgement tone	Replace handset	

Notes







- Calls can only be diverted once. Calls diverted to your are signaled on your telephone even if you have switched on a 'Diversion to' on your telephone.
- Callback calls are not diverted.
- A "Follow me" from a telephone with activated do not disturb to your telephone is possible.

Picking up calls







Another telephone rings. You can pick up the call on your telephone.
If the answering machine has answered an

external call, you can pick up the external call on your telephone.







Picking up an external call

						
External call on another telephone	Lift your handset	Pick up an external call				Hold conversation





Notes

Shortcut - instead of     (Pick up an external call) you can choose the shortcut   (see "Programming shortcuts").

Picking up an internal call

								
Internal call on another telephone	Lift your handset	Pick up an internal call			Enter the internal phone no. of the other telephone	Hold conversation		

Picking up a call from the answering machine

				
Answering machine has answered the external call	Lift your handset	Enter the internal phone number of the answering machine		Hold external conversation

Notes

In order to be able to pick up a call from the answering machine, the terminal connection must be programmed as an answering machine.

Conference

In a conference you telephone with two parties at the same time. Everyone hears what everyone else is saying.

As a conference party you can:













- hold a three-party conference with internal subscribers

- hold a three-party conference with an external subscriber or an internal subscriber or
- hold a three-party conference with two external subscribers. In this case both lines are busy.

Internal three-party conference



										
You are holding an internal conversation	Refer back, enter internal phone number		Refer back call	Refer back		Conference			Acknowledgement tone	Conference with three parties

Internal/external three-party conference

											
You are holding an internal conversation or external conversation	Refer back, enter "0" and external phone number or internal phone number			Refer back call	Refer back		Conference			Acknowledgement tone	Conference with two internal and one external parties

Notes

An external call is signalled to the conference by the external knocking tone if the called party is in a conference.

The conference leader can pick up the external call with  if a line (B-channel) is free. The conference leader is no longer in the conference during the external call. He can switch back into the conference with  providing he has not hung up.

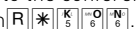
If a subscriber hangs up he leaves the conference. He can only be called by the conference leader in HOLD and be recalled to the conference by the conference leader with .

The conference ends when the conference leader replaces his handset.

Least Cost Routing (LCR) Cost optimised telephoning

You can program the integrated Least Cost Router on your PC with the TK-LCR (part of TK-Soft). You can define which network provider is the cheapest for your needs for eight local code areas (tariff areas) for the respective time of day and day of the week. If you have switched on the Least Cost Router, it automatically uses the entered provider based on the local code. The network code for the current network provider is placed automatically in front of its dialled external phone

number and dialled. You dial in the usual way. If the provider cannot offer a free line after a set number of attempts, the telecommunications systems automatically chooses another pre-defined provider (fallback).

You can switch the Least Cost Routing on and off on your telephone.

As-delivered state: LCR off

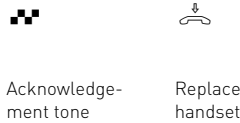
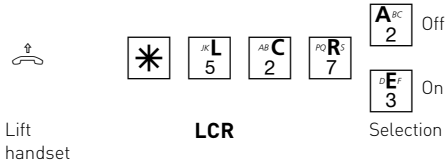

Notes

You can decide which network provider is to be used for an external call even though the LCR is switched on:

You will find a free update in Internet under www.billiger-telefonieren.de

- Just dial the network code of the desired provider in front of the local network code, e.g. 01033.

Important! Not all ISDN features were available from all network providers at the time of going to print (e.g. transmission of phone number to the called party, transmission of connection costs)

Night service

It is defined in the ringing assignment of the telecommunications system which terminal can be called under which multiple subscriber number. Two different call assignments are possible for every multiple subscriber number (MSN) in your telecommunications system with the night service and the day service.

internal or external telephone. En route, you can switch the night service by dialling the switch box of the telecommunications system with the multiple subscriber number (MSN) assigned specifically to the switch box. Also read chapter "Remote Control (Switch Box)". The day service is on when the night service is switched off.

You can switch the night service on and off individually for every multiple subscriber number of your telecommunications system from any

As-delivered state: For all MSN's - night circuit off.

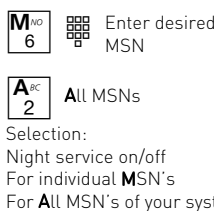

Parking an external call

There are two ways of parking an external call:

- Parking in the telephone system. The line (B-channel) remains busy during parking.
- Parking (replugging on the bus) in the ISDN exchange. The line (B-channel) becomes free when parking in the exchange.

- you want to continue the conversation from another telephone in the telephone system
- Every internal subscriber can pick up (unpark) the external call. If two external calls are parked in the telephone system, the first external call is given priority for unparking.

Parking in the telephone system









You can temporarily interrupt an external call and park it in the telephone system because for example

- you have to leave your desk for a moment,







If the parked external call is not recovered within 4 minutes, you will receive a recall.

The parked external call causes connection costs.

Parking an external call in the telephone system

							
You are holding an external conversation	Refer back	PARk			Acknowledgement tone	Replace handset. The call is parked.	

Recovering an external call (unparking)

					
Lift handset	PARk			The call is unparked, continue external call	

Parking (replugging on the bus) in the ISDN exchange

You can temporarily interrupt an external call and park it in the ISDN exchange because for example

- you want to continue the conversation from another ISDN telephone at the multi-equipment access (bus)
- you have answered a call on the ISDN telephone at the multi-equipment access and want to continue it on an analog telephone of the telecommunications system.



The line (B-channel) becomes free when the call is parked in the exchange.

You have to continue a parked call within 3 minutes. The ISDN exchange disconnects the parked call after 3 minutes.

Since several calls may be parked at your ISDN access, you have to identify every parked call with a "connection ID".

Please see the appropriate operating instructions to find out how to park and unpark a call with an ISDN telephone.

Parking an external call in the ISDN exchange

								Enter index (0 to 9) for connection ID		
Hold external conversation	Refer back	IEI for ISDN park			Index ID			Ackn. tone	Replace handset	

Recovering (unparking) an external call



Lift handset



IAU for ISDN **u**npark



Index ID

Enter the index (0 to 9)
for connection ID



Hold external
conversation

Notes

For ISDN terminals at the external multi-equipment access in which a two-digit connection ID needs to be entered for parking, enter **[0][0]** to **[0][9]**, e.g. **[0][1]**. If you want to continue the call on an analog telephone in the telecommunications system, just enter the 2nd digit, e.g. 1. The telecommunications system first tries to unpark the call with one digit but then adds a "0" to the connection ID, e.g. 01.

If you hear the error tone when parking an external call, an external call is already parked under the entered connection ID. You will be reconnected with the external subscriber after pressing **[R][0]**.

If you hear the error tone when unparking the call, no external call is parked under the entered connection ID.

Connection costs are charged for the parked external call.

Room monitoring

Every analog telephone in the telecommunications system can be used for acoustic monitoring of the room where it is located. For baby sitting for example.

You call the monitoring phone from another internal or external telephone and listen in the room. En route, you can activate room monitoring by

dialling the telecommunications system switch box with the multiple subscriber number (MSN) specially assigned to the switch box.

You have to set up room monitoring on the telephone which is to be used for this purpose.

Setting up room monitoring



Lift handset in the room to be monitored



Activate room monitoring



Acknowledgment tone



Place the handset next to the monitoring phone

Room monitoring by an internal subscriber



Lift handset



Enter the internal phone number of the telephone used for monitoring



Listen into the room

Cancelling room monitoring



Replace handset in the monitored room

Notes

You can also use a telephone in the handsfree mode as a monitoring phone.

Please remember that you can also be heard in the monitored room when you speak.









If you hear the busy tone after dialling the monitoring phone, this means the room is already being monitored by another caller.

Refer back / Brokerage











You can interrupt your telephone conversation and make a refer back call to a second subscriber. Your first call is placed on hold. Then you switch

back to the first call. A held external caller hears a melody if "Music on Hold" (MoH) is switched on or piped in externally.

Internal refer back/Brokerage

					
Hold 1st call	Refer back 1st call is held	Enter internal phone number	Hold refer back call	Refer back call and 1st call are held	
	With "0" to external call or with internal phone no. to internal call			etc.	
Back to 1st call		Continue 1st call			





External refer back/Brokerage

		 			
Hold 1st call	Refer back 1st call is held	Enter "0" and external phone number	Hold refer back call	Refer back call and 1st call are held	
	With "0" to external call or with internal phone no. to internal call			etc.	
Back to 1st call		Continue 1st call			

Refer back in the room (muting)

You can interrupt your telephone conversation and speak to someone else in the room without the

person on the phone being able to hear.

			
Internal or external call	Connection is placed on hold, you can speak without the person on the phone being able to hear	Continue telephone call	Replace handset

Notes

You always have to seize the line with "0" for external refer back/brokerage even when "spontaneous with internal" external seizure is set on the telephone.

If you Replace handset during a refer back call:

- transfer a held external call to the internal subscriber with which you had a refer back call
- receive a callback at-once if a call is still on hold.

The connection costs for the external call continue even when the call is on hold.

Callback (Knocking)

The subscriber you want to reach is telephoning or does not answer. To avoid having to call back again and again, you can activate a callback. You then get a callback as soon as he hangs up or ends a call. Your phone rings. You just have to lift handset and the subscriber is called automatically.

Callback on busy from an external subscriber is only possible if your network provider supports the ISDN feature.

You will receive an automatic callback as soon as the subscriber is free.

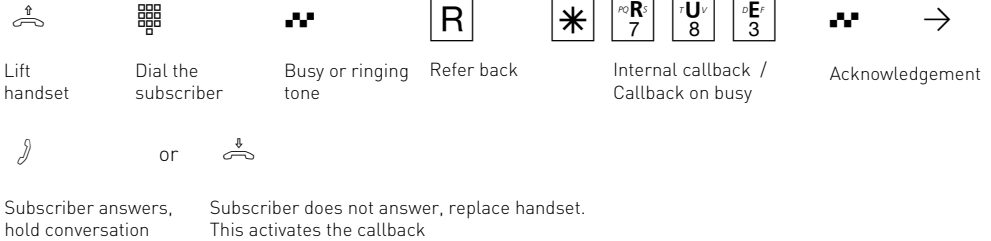

Notes

Callback - you can activate several callbacks one after another (from any internal subscriber). You cannot activate a callback from an internal subscriber

- from which another subscriber is already expecting a callback
- who has switched on do not disturb on his telephone
- whose connection is set to the terminal type answering machine, fax, modem or combi-device.

Callback from an internal subscriber:

- The callback is disconnected after 60 seconds if you do not answer.
- A callback is cancelled if the callback was not connected.

General callback:
You have activated a callback:

- If the do not disturb feature is switched on on your phone, it will be temporarily deactivated.
- If a call diversion is set up on your phone, the callback is not diverted.

In the event of a power failure: Callbacks are cancelled.

You cannot use the "Callback" features on a combi-device (phone/fax).

Callback on busy

- No callback from the desired subscriber is possible when you hear the error tone. The ISDN feature "Callback on busy" is not available in the exchanges for example.
- If you are unavailable for callback, the callback is disconnected after 20 seconds and cancelled. Repeat the callback if necessary.
- A callback is cancelled when the callback has been connected or is not connected within 45 minutes.

Do not disturb

You do not want to be disturbed by calls and switch off the tone call on your phone. You can still make calls as usual. On lifting the handset,

the special dialling tone reminds you that the tone call is switched off.

As-delivered state: Do not disturb off

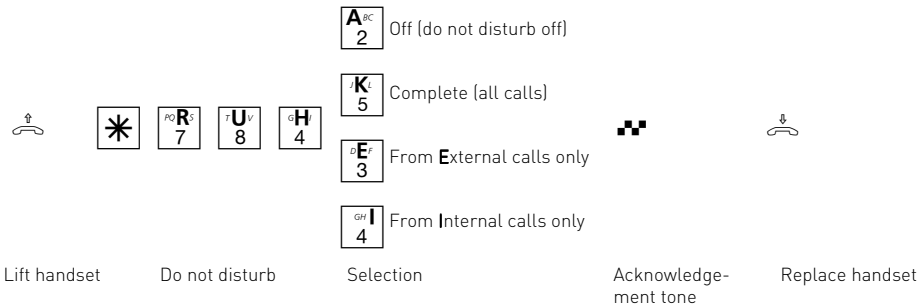

Lock (dialling lock) – Direct call (baby call)

Lock - You can protect your phone against unauthorised use by locking it.

When your telephone is locked you can:

- only call internal subscribers with and the internal phone number
- answer all incoming calls and pass them on internally if necessary.
- only dial the stored direct phone number (baby call number) and the stored number for automatic dialling externally. You have to activate the automatic dialling before locking your phone.

(Personal Identity Number). If you hear the busy tone when unlocking the phone, you have to enter the PIN after . No PIN is defined (**as-delivered state**) for your phone if you hear the short acknowledgement tone. If you have forgotten your PIN, you will have to contact your dealer. Only he can reset the PIN.

Direct call (baby call) - The telephone is locked. After lifting the handset and pressing any key except and , the stored direct number is dialled automatically. Ideal for children who are not old enough to dial phone numbers.

Telephone PIN - You can protect your phone against being unlocked by entering a 4-digit PIN

Lock off / on



Entering / resetting the telephone PIN

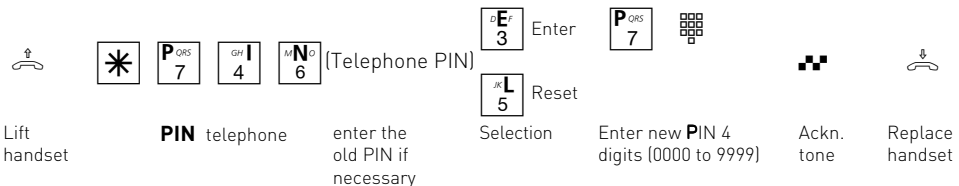

Entering / resetting the direct phone number

Start programming mode: * (system PIN)

PRO

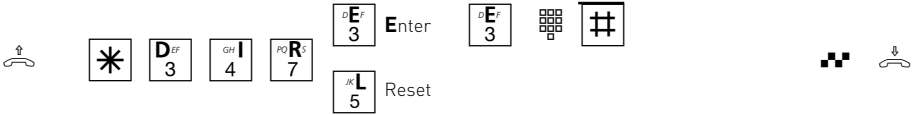

Lift handset

DIRect phone number

Selection

Enter external phone number (direct phone no.) without "0" (external seizure) and without own local code

Ackn. tone

Replace handset

Continue programming or exit programming mode: *

END

Phonebook - Saving and dialling phone numbers

You can save 200 phone numbers in the phonebook. You can save phone numbers under a certain short dialling index with the connected terminal. It is also possible to save the phone numbers with a name on the PC.

The destinations of the phonebook can be dialled by all subscribers irrespective of their external authorisation.

In addition to external call numbers you can also save * procedures in the phonebook. You can then also use all the procedures even on telephones which do not support * and #.

You can select a phone number from the phonebook with the short dialling index or the name. There is no need to remember the short di-

alling index if you have the Vanity feature. Just enter the name. As soon as the telecommunications system has clearly identified an entry, you will hear the acknowledgement tone. Example:

Entries in the phonebook

Selection with

Adenauer

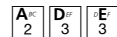

AGFEO



Bergmann



Cerner

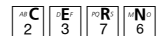

Phonebook - Dialling phone numbers

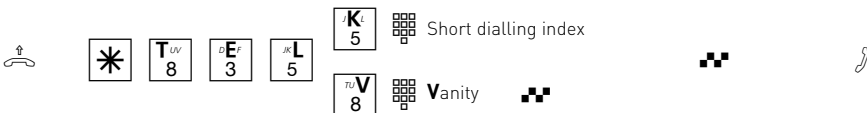

Lift handset

Phonebook

Enter short dialling index 000 to 199 or Vanity (name)

Ringing tone if name was clearly identified. The destination is dialled after 4 sec or at once after

Ringing tone, subscriber is called

Subscriber answers, hold conversation





Notes

You can post dial further digits after dialling a phonebook destination.

You will hear the error tone (busy tone) if you dial an empty phonebook destination.

If the barred range of the telecommunications system is programmed for your telephone, you cannot dial the phonebook numbers which are in













the barred range. You will hear the error tone

Shortcut - instead of     (Execution of the telephone book with enter facility by vanity) you can choose  (**As-delivered state**, see "Programming shortcuts").







Phonebook - Saving / cancelling phone numbers

Start programming mode:      (system PIN)  

PRO

	   	 Enter	 Short dialling index 000 to 199	→ Continue input
		 Cancel	 Name  	
Lift handset	Phonebook	Selection	Selection: Enter short dialling index 000 to 199 under which you want to save a phone number. Enter vanity mark and name, if the name is unequivocal in the telephone book, you hear a continuous tone. Press the key  to stop it.	

 			
Enter external phone number (without "0" outside line seizure) or  procedure	Finish input	Ackn. tone	Replace handset

Continue programming or exit programming mode:       

END

Notes

When entering vanity names, you should care for them to be unequivocal. Enter them fully. Enter a blank between family name and christian name by pressing the key .

A name entered by telephone appears in the TK-Set as a series of numbers, because there is only an unequivocal assignment of letters to numbers.

Timer (timing control with weekly profile)

The telecommunications system provides you with 10 timers. You can use these timers to switch the telecommunications system on or off at certain times and on certain days of the week.

The timers control the following functions:

- day, night service
- call forwarding (internal)
- busy on busy
- privilege
- lock (dialling lock)
- do not disturb
- diversion – divert call to another phone

The timers can be programmed with the TK-Set program.

You can switch every timer on and off for every telephone

En route, you can switch a timer by dialling the telecommunication system switch box with its specially assigned multiple subscriber number (MSN). Read chapter "Remote Control (Switch Box)".

As-delivered state: all timers off

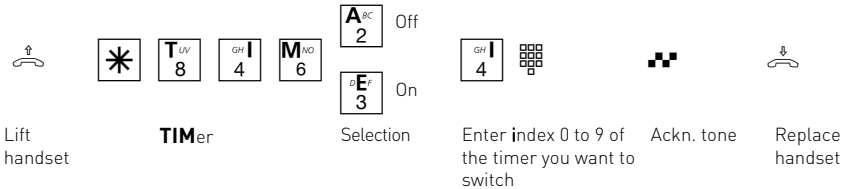

Transmitting your phone number

Your telecommunications system offers you the possibility of suppressing transmission of your phone number (MSN) to your partner.

Two different transmission possibilities are available in ISDN:

- Transmitting the called party's phone number to the caller

Your phone number (MSN) is transmitted to the external ISDN subscriber who calls you

- Transmitting the phone number of the caller to the called party

Your phone number (MSN) is transmitted to the external ISDN subscriber whom you call.







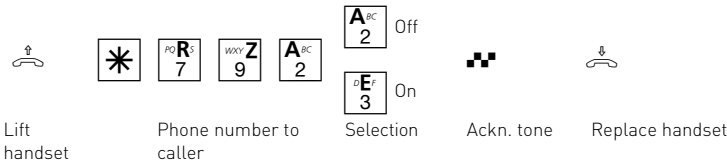

As-delivered state: Transmission of phone numbers to called party and caller – on.

Transmission of the phone number and its possible suppression are ISDN features and are only possible if your network provider offers them.

Switching transmission of your phone number (MSN) to the caller on/off







Switching transmission of your phone number (MSN) to the called party on/off

						Off		
Lift handset		Phone number to called party				On	Ackn. tone	Replace handset
				Auswahl				

Notes

You local code and multiple subscriber number (MSN) [e.g. 030 87654323] assigned to you by the programming is transmitted at the **multi-equipment access**.

You can transmit another MSN for external dialling to separate the costs specifically. To seize the outside line, dial the procedure    - multiple subscriber number  external phone number instead of "0".

Display caller number (CLIP)

See who is calling you: on analog terminals with caller number display (CLIP function) the TK system displays the caller number unless the caller has withheld it. The caller's name will also be displayed if you have stored the name and telephone number in the TK system's phone









book. The time and date will also be shown. Individual CLIP options must be activated during programming.







You can switch the CLIP function on and off on your handset.

Display - caller number/name (CLIP): switch on/off

Start programming mode:      (system PIN)  

PRO

						Off		
Lift handset		CLIP, display caller number				On	Ackn. tone	Replace handset
				Selection				

Continue programming or exit programming mode:       

END

Diversion – diverting calls to another telephone

Diversion via the telecommunications system:

The telecommunications system diverts all calls for a fixed internal phone number to another specified destination. A diversion destination may be another internal subscriber or an external subscriber.

The telecommunications system uses both B-channels (lines) to divert an external call to another external phone number.

Despite the diversion you can still make telephone calls in the usual way. On lifting the handset, the special dialling tone reminds you that the diversion is activated.

Diversion via the ISDN exchange:

The "ISDN call forwarding" feature can only be used if your network provider offers it.





















The ISDN exchange diverts all calls made to the fixed multiple subscriber number to another external destination which you specify. The B-channels (lines) of the telecommunications system stay free.

There are three variations for call diversions: permanent, when busy or not answering after 20 seconds.













En route, you can switch a diversion by dialling the switch box of the telecommunications system with its specially assigned multiple subscriber number (MSN). Read the chapter "Remote Control (Switch Box).

The green LED of the telecommunications system flashes slowly when an external diversion is switched on.













Programming and activating (switching on) a diversion

 Lift handset	 Diversion	 Permanent  When busy  Not answering (after 20 s)	→ Continue with: 1) Divert internal phone number or 2) Divert MSN
<h3>1) Divert internal phone number through the telecommunications system</h3>		 External phone number  Internal phone number  Short dialling index  Name from phonebook (Vanity)	  
	Enter internal ID and internal phone number which you want to divert	Diversion destination ID for: E xternal phone number I nternal phone number S hort dialling index V anity	Ackn. tone Replace handset
<h3>2) Divert MSN via the ISDN exchange</h3>		 External phone number  Short dialling index  Name from phonebook (Vanity)	  
	Enter MSN ID and MSN which you want to divert	Diversion destination ID for: Kennzeichen für E xternal phone number S hort dialling index V anity	Wait for ackn. tone (max. 1 minute) Replace handset

Deactivating a diversion (switching off)

							Internal phone number			
Lift handset		DEA ctivate (switch off)			M ^{NO} 6		MSN			
					Selection: Internal phone number or MSN		Enter internal phone number or MSN which you want to deactivate			
									Wait for ackn. tone (max. 1 minute)	Replace handset

Activating a diversion (switching on)

							Intern-rufnummer				
Lift handset		A ctivate (switch on)			M ^{NO} 6		MSN				
					Selection: Internal phone number or MSN		Enter internal phone number or MSN which you want to activate			Wait for ackn. tone (max. 1 minute)	Replace handset

Notes

Diversion via the telecommunications system

You can only program a "diversion to" for an internal phone number. When you program a diversion, you delete an existing diversion and replace it with a new one.

Your telephone may be the diversion destination of all other internal subscribers.

Diverted external calls can also be answered at telephones which only usually allow internal traffic.

Calls can only be diverted once. Calls diverted to you are signalled on your telephone even if you have switched on a diversion on your phone.

Callbacks are not diverted.

Diversions to a telephone with the do not disturb function activated are not possible.

You hear the error tone when switching on the diversion if you have selected an empty short dialling destination.

Diversion to an external subscriber

For the external diversion

- a line must be free
- the diverter must have authorisation for the external phone number

You bear the costs for the external diversion.

Diversion via the ISDN exchange

You can only program one diversion per multiple subscriber number (MSN).

If ISDN call forwarding is switched on, you will hear the special dialling tone of the ISDN exchange after seizing the line.





Note that up to one minute may pass between activation, deactivation and acknowledgement tone for forwarded ISDN calls. Do not Replace handset during this time.

Connection costs

Cost menu – Overview:

Your telecommunications system can record the costs of calls if your network operator offers the ISDN feature "Transfer connection costs at the end of the call" and the providers you use also transmit these.

For technical reasons the data on the telephone bill may differ from the connection cost totals of your telecommunications system. The network operator's tariff unit counter is always the last instance.

PIN (Personal Identity Number) – You can protect access to the costs menu by entering a 4-digit cost PIN. If you hear the busy tone when you start the cost menu, you have to enter the cost PIN after    . If you hear the short acknowledgement tone, no PIN is defined for the cost menu.

If you forget the cost PIN, you can change it with TK-Set on the PC or contact your dealer.

Set decimal places - before entering the factor for a charging unit set the number of decimal places which you wish to be shown. 0 to 3 decimal places are possible.

Factor for a tariff unit – Use the maximum 4-digit **user factor** (e.g. 0,121 DM per unit) to define how much a tariff unit costs for every internal subscriber.

With the maximum 4-digit **basic factor**, set your telecommunications system to the amount (e.g. 0,121 DM per unit) which the network operator charges for one tariff unit.

Limit / Disconnect at limit – You can define a 7-digit cost limit (Pfennigs) for every internal subscriber. You can also define what is to happen when the cost limit is reached. Can the internal subscriber continue the conversation he has begun but not start a new external call or will the connection be cut off. The subscriber can only make external calls again after clearing his total costs.

Exception: The direct phone number can also be dialled on reaching the limit.

Communication of charge pulses on / off - On an analog telephone, you can display connection costs if the telephone has a units counter. To display connection costs, you must activate communication of the charge pulses for your telephone on your telephone.

If you have requested the "communication of connection charges during of the connection" feature from your network carrier, your telephone continuously displays the costs during a connection.

Define charge pulses -The charge pulse the PBX sends to analog telephones may be switched from 16 kHz to 12 kHz.

The analog phones available in Germany usually use the 16 kHz-pulse.

Your PABX can transmit charge pulses to analog telephones only, if your operator provides the ISDN function "Advice of charge" and your network provider is able to transmit them.

As-delivered state:

- PIN no entry
- 2 decimal digits
- User factor 0,12 DM
- Basic factor (network operator) 0,12 DM
- Limit no entry
- Disconnect at limit off
- Cost log off for all subscribers
- Transmission of charge pulses activated
- Charge pulses: 16 kHz

N. B.! You cannot telephone as long as the cost menu is started. You hear the special dialling tone when you lift handset. You cannot telephone again until the cost menu has been exited.

Entering /cancelling PIN for the cost menu

Start cost menu: * (cost PIN)

KOS

* Enter
 Cancel

Lift handset

PIN

Selection

Enter 4-digit PIN

Ackn. tone

Replace handset

Continue cost menu or exit cost menu: *

END

Entering number of decimal digits for tariff units

Start cost menu: * (cost PIN)

KOS

*
Lift handset Decimals Enter number of decimal digits Ackn. tone Replace handset

Continue cost menu or exit cost menu: *

END

Entering / cancelling factor

Start cost menu: * (cost PIN)

KOS

* Enter Basic
 Cancel User

Lift handset Factor Selection Select factor Enter amount (Pfennigs, max. 5 digits) Ackn. tone Replace handset

Continue cost menu or exit cost menu: *

END

Entering / cancelling limit

Start cost menu: * (cost PIN)

KOS

* Enter
 Cancel

Lift handset **LIM**it Auswahl Enter internal phone number for which you want to define a limit Enter amount (Pfennigs, max. 7 digits) Ackn. tone Replace handset

Continue cost menu or exit cost menu: *

END

Disconnect at cost limit

Start cost menu: * (cost PIN)

KOS

					Off		
				On			

Lift handset Disconnect Selection Ackn. tone Replace handset

Continue cost menu or exit cost menu: *

END

Communication of charge pulses on / off

Start cost menu: * (cost PIN)

KOS

					Off		
					On		

Lift handset Communication of charge pulses Selection Ackn. tone Replace handset

Continue cost menu or exit cost menu: *

END

Define charge pulse

Start cost menu: * (cost PIN)

KOS

					Twelve (12 kHz)		
					Sixteen (16 kHz)		

Lift handset Define charge pulse Selection Ackn. tone Replace handset

Continue cost menu or exit cost menu: *

END

Notes

If you want to reject your input in the cost menu and restore the setting which you saved last, exit the cost menu with instead of with

*

ESC

Display charges for the last call

You can have the costs of your last call which are stored in the TK system displayed at any time. You must simply ensure that you have requested

"notification of costs at the end of the call from your network operator.





Lift handset

Cost of last call

Acknowledgement tone; wait until the display appears!

Replace handset

Notes

If you wish to display the costs of the last connection by entering   , please note that your telephone's totalizer may total up the costs of the last connection.

For technical reasons, the data on the network carrier's invoice may deviate from the total connection costs displayed by the telephone system. The charge units counter in the network carrier's exchange is always binding.

Forwarding (internal)

The telecommunications system forwards an external call to another external terminal when you switch on forwarding. The terminals of a forwarding must be defined for each MSN telephone number of your system by programming the MSN assignment.

any internal or external telephone. En route, you can switch the forwarding on or off by dialling the switch box of the telecommunications system with the specially assigned multiple subscriber number (MSN). Read the chapter "Remote Control (Switch Box)".

Forwarding takes place:

- according to a fixed number of rings if no-one answers
- immediately if the called party is busy and knocking is not possible.

The terminal to which the call is forwarded is defined for every phone number in your telecommunications system by programming the ringing assignments.

You can switch the forwarding on and off separately for every multiple subscriber number (MSN) of your telecommunications system from

As-delivered state: Forwarding (internal) off for all MSN's



Off



On



Lift handset

Forwarding

Selection

Enter MSN's of your telecommunications system for which you want to switch forwarding on/off individually or All MSN's of your telecommunications system

Ackn. tone

Replace handset

Programming the telecommunications system

Your telecommunications system is set after installation so that you can telephone immediately and use the functions of the telecommunications system immediately.

The programming of the telecommunications system is very flexible so that you can set it up to

meet your own personal requirements.

You have the following possibilities for programming your telecommunications system:

- Programming with a PC
- Remote configuration by the dealer
- Programming with a telephone

Programming the telecommunications system with a PC

You can program your telecommunications system from a PC/laptop via the PC interface without knowledge of a programming language. Easily comprehensible menus guide you through

the configuration program. The "TK-Set" configuration software is part of the TK-Soft software package which can be found on the enclosed CD.

Minimum PC requirements

- IBM or compatible PC with hard disk and CD ROM drive
- Pentium II or higher
- Working memory minimum 32 MB
- Microsoft Windows 98/2000, ME, NT 4.0
- RS 232 C interface

Installing TK-Soft

- Insert the CD in your CD ROM drive. The Installation Software starts automatically.
- Select "AGFEO TK-Soft for AS ISDN systems" from the CD Menu
- Click on the "install" field.
- When prompted to do so, enter the path and confirm it. All files required are now automatically copied from the diskette to your hard disk.

If the automatic-start function is deactivated on your system, please do as follow:

1. Select /doubleclick) the symbol "My Computer" on your desktop.
2. Open the symbol for your CD ROM drive
3. Start the Programm Setup(.exe).

Continue as described under "Select from the CD menu."

Connecting the PC to the telecommunications system

- Connect the PC interface (D-SUB-9 socket) of the telecommunications system to the PC's COM port.
- Use a one-to-one V.24 connecting cable plug – socket for the connection. It should not be longer than 3 m.
- Start the configuration program.
- Configure the telecommunications system. Your entries are accepted interactively with user guidance.
- Disconnect the cable from the telecommunications system on completing the configuration.

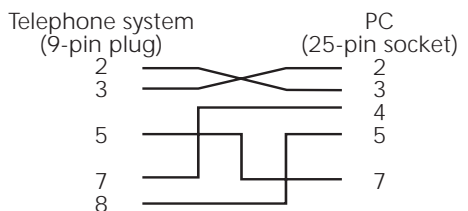
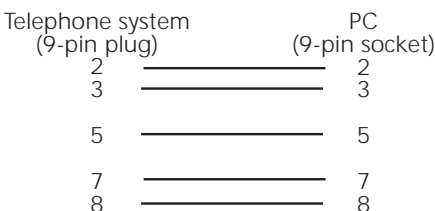

Connection assignment of the PC cable

Remote configuration – Remote Service

Your dealer can program your telecommunications system with the remote configuration to suit your requirements. Without visiting you at home simply by using your S0 basic access. Data security is guaranteed at all times.

Before remote servicing can take place, you have to enter your dealer's remote service number or the service number of the service center in your telecommunications system.

Remote service is only possible when the saved remote service number or service number matches the transmitted phone number.

You also decide when and what can be programmed by releases. For example, whether the phonebook numbers can be read and written.

If you have released the remote service, the dealer can read out, edit and write back the programming in your telecommunications system. The remote service is allowed initially for 8 hours. The remote service is automatically barred eight hours after the last connection between the programming PC and the telecommunications system. You may have to terminate your programming for remote service.

Remote configuration – Entering the remote service number

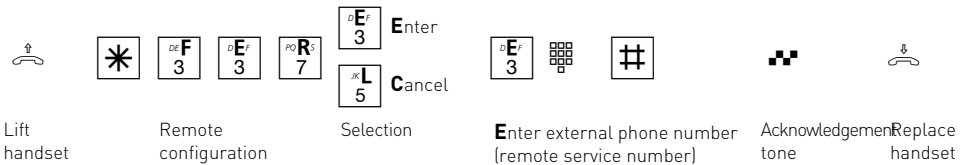

Releasing the remote service

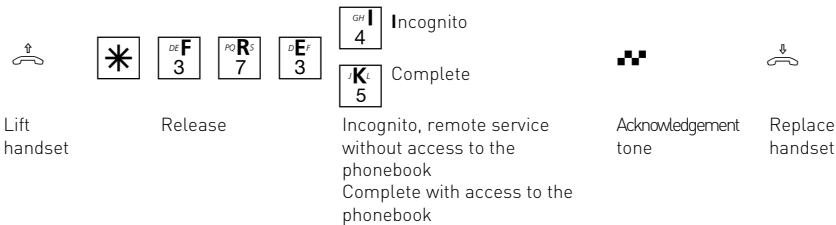

Programming the telecommunications system with a telephone

Notes on programming with a telephone

Programming with a telephone always involves the steps:

- Start the programming mode,
- Input
- Exit the programming mode.

Listen to the dialling tones or pulses in the earphone when programming. Wait after entering every digit until the digit is dialled. You may hear

the Acknowledgement tone if your entry is valid or the error tone (busy tone) if your entry is invalid.

Recommendation: Use a telephone with DTMF dialling for faster programming.

If you use a telephone with handsfree facilities, you can press the loudspeaker key instead of "Lift handset" or "Replace handset".

Starting the programming mode

In order to be able to change settings, you first have to start the programming mode. Then you can make all the settings for your telecommunications system one after the other.

N.B.! You **cannot** use the phone whilst you are in the programming mode. You hear the programming tone on lifting the handset.



Lift handset



(system PIN)

Start **PRO**gramming mode



Acknowledgement tone, otherwise enter the system PIN



Replace the handset

Entering the system PIN?

If you hear the short Acknowledgement tone after , no system PIN is programmed in the telecommunications system. It is not necessary to enter the system PIN.

If you do not hear a tone after , a system PIN is programmed in the telecommunications system. Enter the 4-digit system PIN. If the PIN is correct, you will hear the Acknowledgement tone. If the PIN is wrong, you will hear the error tone.

Input

After lifting the handset, enter and the first three letters of the name of the function or and the 3-digit code. Then enter other parameters (on or off, phone numbers etc.). All entries for a function are terminated by replacing the handset. If you make an error, replace the handset and start again from the beginning.

Acknowledgement tone or error tone

If an entry is invalid, you will immediately hear the error tone (busy tone). Replace the handset and start again from the beginning.

You will hear the short Acknowledgement tone when all entries are clearly terminated and valid.

Restoring old settings

You can try out settings in the programming mode. Settings are not saved until you exit the programming mode. You can restore the settings

last saved beforehand. The programming mode is then exited automatically.



Lift handset

ESC (old settings)

Acknowledgement tone

Replace handset

Exiting the programming mode

Exit the programming mode after you have made all the settings. The new settings are then saved.

The settings are retained even in the event of a power failure.



Lift handset

END (exit programming mode)

Acknowledgement tone

Replace handset

Restoring the as-delivered state

If the programming is unclear, you can restore the as-delivered state during the programming mode (clear memory).

Clear memory – Attention! All existing connections are cleared. Wait about 2 minutes! The programming mode is exited.

Start programming mode:      (system PIN)  
PRO



Lift handset

Restore as-delivered state

Acknowledgement tone

Replace handset

Saving multiple subscriber numbers

Save every multiple subscriber number (MSN) which your network provider has assigned for your ISDN multi-equipment access in your telecommunications system. Your telecommunications system can save up to 10 multiple subscriber numbers. Enter every multiple subscriber number singly and without the

local network code after the following * procedure. When you select "Fast", you save the MSN's and at the same time the terminal on which you have executed this function is also in the call assignment of this MSN.

Start programming mode: * (system PIN)

PRO

						Enter			Enter MSN			
Lift handset	Save MSN					Delete					Ackn tone	Replace handset
						Fast				Delete all MSN's		
						Selection:						
						Delete all MSN's						

Continue programming or exit programming mode: *

END

Defining ringing assignment

In a ringing assignment you define which terminals of your telecommunications system are to be called under which multiple subscriber numbers (MSN). You can assign one or more terminals to an MSN.

You can define three call assignments to every multiple subscriber number of your telecommunications system:

- the day service
- the night service
- the forwarding service (internal)

You can switch over the **day/night service** at any time from any telephone, even en route.

In the **Forwarding (internal)** you define to which terminals of your telecommunications system the call is to be forwarded when a call is not answered under an MSN. In this case, you define after how many ringing cycles the call is forwarded. It is forwarded immediately if the subscriber(s) of an MSN is (are) busy.

The forwarding is only active when switched on. You can switch it on and off from any telephone, even en route.

As-delivered state:

- Day service on for all MSN's, no internal phone number entered, the internal phone numbers 11, 12 and 13 are called in the case of an external call.
 - Night service off for all MSN's, no internal phone number entered
 - Forwarding (internal) off for all MSN's, no internal phone number entered
- Cycles (number of rings) until forwarding: 5

Internal phone numbers of your telecommunications system:

11 (connection 1), 12 (connection 2), 13 (connection 3), 14 (connection 4), 50 (switch box)

You can reach the PC connected to USB by dialling internal numbers 20 to 29.

Day service

Start programming mode: * ^P7 ^R7 ^O6 (system PIN)

PRO

* ^TUV 8 ^ABC 2 ^G4 ^E3 ^L5 ^MNO 6 [#] ^{GH}I 4 [#]

Lift handset

Day service

Enter
Delete

MSN
ID

Enter MSN for which day service is defined

Internal ID

Internal phone no. which is to be called (see notes)

Ackn. tone

Replace handset

Continue programming or exit programming mode: * ^E3 ^N6 ^D3

END

Night service

Start programming mode: * ^P7 ^R7 ^O6 (system PIN)

PRO

* ^MNO 6 ^ABC 2 ^ABC 2 ^E3 ^L5 ^MNO 6 [#] ^{GH}I 4 [#]

Lift handset

Night service

Enter
Delete

MSN
ID

Enter MSN for which night service is defined

Internal ID

Internal phone no. which is to be called (see notes)

Ackn. tone

Replace handset

Continue programming or exit programming mode: * ^E3 ^N6 ^D3

END

Call forwarding

Start programming mode: * ^P7 ^R7 ^O6 (system PIN)

PRO

* ^WXYZ 9 ^E3 ^{GH}I 4 ^L5 ^MNO 6 [#] ^{GH}I 4 [#]

Lift handset

Call forwarding

Enter
Delete

MSN
ID

Enter MSN for which call forwarding is defined

Internal ID

Internal phone no. which is to be called (see notes)

Ackn. tone

Replace handset

Continue programming or exit programming mode: * ^E3 ^N6 ^D3

END

Notes

Several internal phone numbers can be entered as follows: ... ^{GH}I 4 ^{GH}I 4 ... [#]

All the assigned internal phone numbers are deleted when clearing a ringing assignment (day, night service or call forwarding) of an MSN.

If you want to use the telecommunication system's switch box, you should not enter the internal phone number 50 of the switch box with an answering machine in the ringing assignment of a multiple subscriber number. The answering machine may answer the call before the switch box.

Ringing cycles before forwarding

Start programming mode: * (system PIN) **PRO**

*

Lift handset Cycles (number of rings) Input ID Number of MSN rings (2 to 8) Enter MSN for which forwarding is defined Ackn. tone Replace handset

Continue programming or exit programming mode: * **END**

Setting the rhythm for external calls

You can assign different ringing rhythms to 5 MSN's in order to be able to hear from the ringing whom the caller wants to speak to.

As-delivered state: Rhythm 0 (standard) for all MSN's.

Start programming mode: * (system PIN) **PRO**

*

Lift handset **Rhythm** Enter, rhythm 0 to 4 Enter MSN for which the rhythm is to apply Acknowledgement tone Replace handset

Continue programming or exit programming mode: * **END**

Notes

All ringing rhythms for incoming external calls start with an initial ring of 500 ms. This is followed by a 2 s pause. This is for technical reasons to transmit the phone number of the caller (CLIP).

Then it is possible to distinguish calls under different multiple subscriber numbers (see the diagram).

Ringing rhythms

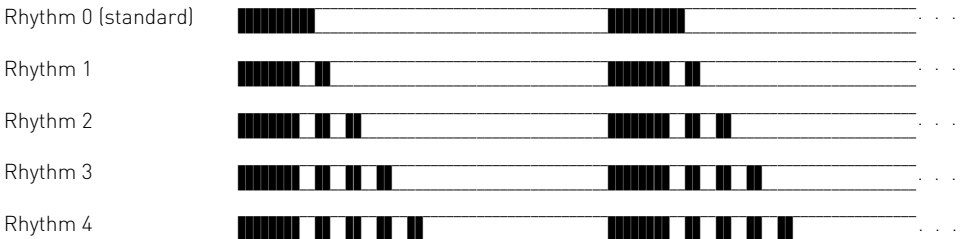

The calls may deviate depending on the terminal used.

Programming access to the ISDN network

You define which multiple subscriber number(s) of the telecommunications system every internal subscriber can use to set up an external connection. The connection costs are registered under this multiple subscriber number (MSN) which is transferred to the called party.

You define one of the three authorisations for every MSN:

Preferred – this MSN is transmitted automatically in the case of external seizure “spontaneous with internal” or with “0”.

Free – these MSN’s can be selected for external seizure by the internal subscriber. On the telephone by entering and the MSN. This is only possible when the external seizure “spontaneous with internal” is switched off. If the internal subscriber is authorised for several multiple subscriber numbers, the first assigned MSN is transmitted spontaneously at external seizure or with “0”.

Barred – this MSN is barred for the internal subscriber.

As-delivered state: All internal subscribers have free access to the ISDN network through every MSN.

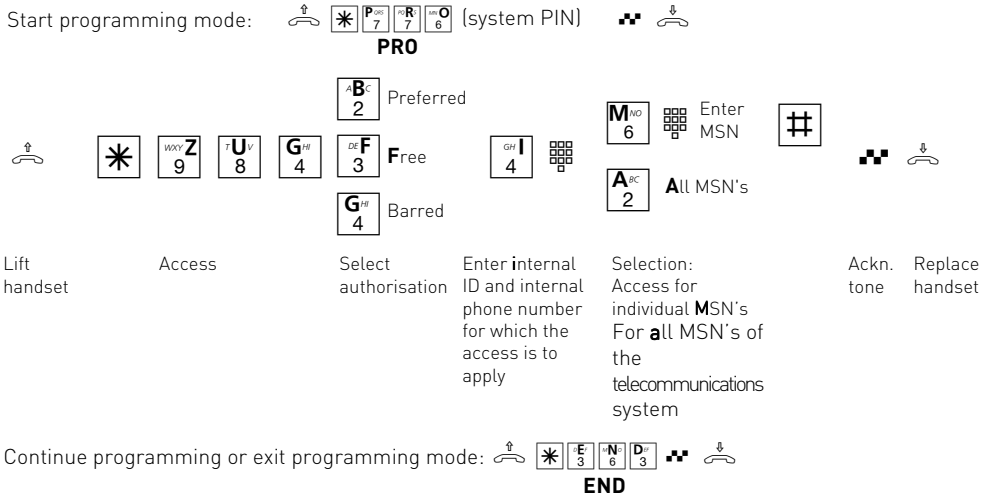

Defining authorisation

Normally every subscriber can telephone all over the world.

However, you can define how far every single phone may call:

- non-restricted
- domestic
- regional numbers table (the regional numbers must be entered additionally)
- City/local calls
- none (only answer incoming calls, semi-restricted)

As-delivered state: non-restricted for all subscribers

Irrespective of the authorisation, you can define that every subscriber cannot dial certain phone numbers (programmed under "Barred numbers").

Start programming mode: * (system PIN)

PRO

		Full						
		Domestic						
					Table regional			
		City/Local						
		None						

Lift handset Authorisation Selection Enter internal ID and internal phone number for which the authorisation is to apply Ackn. tone Replace handset

Continue programming or exit programming mode: *

END

Notes

All subscribers can dial all the phone numbers in the phone book irrespective of the programmed authorisation.

Phonebook numbers which are barred by the barred numbers function cannot be dialled by subscribers with the "Barred numbers" assignment.

Programming regional numbers (free range)

You have defined how far a telephone may call under "Authorisation". If you have set "Table regional numbers" there, you can program up to 10 codes (index 1 to 9, 0, max. 6 digits) which you can define as a region.

If you enter 022 for example, the subscriber with regional authorisation can dial numbers

beginning with 022 in addition to making local calls:

- He can dial e.g.: 0221, 0228, 02241, 0228.
- He cannot dial e.g. 0211, 0231, 0288.

As-delivered state: No regional numbers defined.

Start programming mode: * (system PIN)

PRO

					Enter					
Lift handset	Regional numbers	Selection	Enter index ID and index 1, 2 ... 9, 0	Enter code ID and code number max. 6 digits	Ackn. tone	Replace handset				

Continue programming or exit programming mode: *

END

Programming barred numbers

You can bar 10 number (index 1 to 9, 0) ranges. Barred numbers beginning with these codes cannot be dialled. The barred numbers can be assigned to every subscriber in the

telecommunications system additionally irrespective of the authorisation.

As-delivered state: No barred numbers defined, no barred numbers assigned.

Entering barred numbers

Start programming mode: * (system PIN)

PRO

					Enter					
Lift handset	Barred numbers	Selection	Enter index ID and index 1, 2, ..., 9, 0	Enter code ID and code number max. 6 digits	Ackn. tone	Replace handset				

Continue programming or exit programming mode: *

END

Assigning the barred numbers

Start programming mode: * (system PIN)

PRO

					Off				
Lift handset	Assign barred numbers				Selection	Enter internal ID and internal phone number		Acknowledgement tone	Replace handset

Continue programming or exit programming mode: *

END

Entering terminal types

Settings are available dependent on the connected terminal types. Certain functions are then automatically active.

Make the setting on every terminal:

- **Telephone:** The knocking prevention is switched off and can be switched on. A call with the "Fax" service ID is not signalled.
- **Answering machine:** The knocking prevention is switched on permanently. Anyone can pick up a call from this connection.
- **Fax:** The knocking prevention is switched on permanently. A call cannot be picked up. The "Fax" service is transmitted. Calls with the "Fax" service ID are always signalled at this connection.
- **Modem:** The knocking prevention is switched on permanently. A call cannot be picked up.
- **Combi-device:** A combi-device is a telephone with integrated fax. In the combi-device a call is

generally assigned where it is to be signalled according to the set ringing assignment irrespective of the transmitted service ID. In the case of external seizure with "0", use the "Telephone" service. In case of external seizure with "10" use the "Fax" service. The knocking prevention is switched on permanently.

As-delivered state:

- Connection 1 – telephone, internal phone number 11
- Connection 2 – telephone, internal phone number 12
- Connection 3 – answering machine, internal phone number 13
- Connection 4 – combi-device, internal phone number 14

Start programming mode: * (system PIN)

PRO

					Enter						TELEphone		
					Delete (telephone)						Answering machine		
											FAX		
											MODem		
											Combi-device		

Lift handset **TYPE** of terminal Selection **V**anity Selection Ackn. tone Replace handset

Continue programming or exit programming mode: *

END

Programming short commands

You can program a function which you want to use frequently as a short command.

Two short commands which you can select with ***0** or ***1** on every telephone are available in your telecommunications system.

The following standard functions are stored as short commands in the **as-delivered state**:

***0** = ***T₈E₃L₅V₈**
 (Call the phonebook with Vanity input)

***1** = ***H₄O₆E₃**
 (Pick up an external call)

You can program any function as short command 0 or 1. Every function starts with *****.

You can also combine several functions in one short command.

Example: Entering / cancelling limit
 Enter the individual functions after index 0 or 1. Do not replace the handset!

***K₆O₇S₇** - start cost menu

***L₅M₄M₆** - entering / cancelling limit

***E₃N₆D₃** - exit cost menu

If you replace the handset before terminating the short command input with ***K₆U₉R₇**, the entry will be cancelled.

If you delete or cancel a short command input, the appropriate standard function is programmed again.

Start programming mode: ***P₇R₇O₆** (system PIN)

PRO

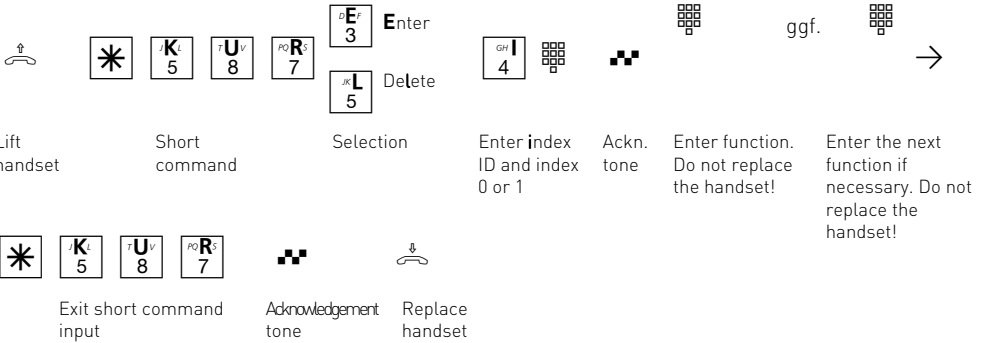

Continue programming or exit programming mode: ***E₃N₆D₃**

END

Setting list of callers

The telecommunications systems saves external calls which no internal subscriber has answered in a list (call list). You can display and print the list with the "TK-Phone" program on the PC. The "TK-Phone" program is part of the TK-Soft software package.

1. Interrogate selection:

- Off – no list of callers is saved for this connection.
- Phone number – All external calls which transmit the phone number are saved for this connection.
- Phonebook – Only those external calls which transmit the phone number and are listed in the telecommunication system's phonebook are saved for this connection.

2. Specify to whom the selection should apply:

- Internal subscriber (eg 11)
- All internal subscribers

As-delivered state: Off – no list

The call list contains the following information:

- date and time of the call
- phone number/name of the caller (if the phone number is not transmitted, the caller's phone number is marked "unknown")
- multiple subscriber number of the internal subscriber
- service (telephony, fax, data)

The green LED of the telecommunications system flashes rapidly when an entry is saved in the list. The LED stops flashing rapidly when the list has been read out with "TK-Phone".

Start programming mode: (system PIN)

PRO

						Phone number			Internal phone number		
Lift handset	LIST of callers (call list)	Selection	Off	Phonebook	Selection:	Enter internal ID and internal phone number or	All internal phone numbers	Acknowledgement tone	Replace handset		

Continue programming or exit programming mode:

END

Brokerage – Setting the variant

In brokerage you switch back and forth between two parties. One subscriber is held whilst you are speaking to the other one and cannot hear what you are saying. For brokerage with external subscribers, you can define whether the brokerage (Hold) is to take place in your telecommunications system or in the ISDN exchange (Exch).

Difference when brokering with two external subscribers:

Brokerage in the telecommunications system –
The two lines (B-channels) are busy. Another external connection is not possible.

Brokerage in the Exch (HOLD) – Only one line (B-channel) is busy. The 2nd B-channel is free for another external connection.

As-delivered state: Brokerage in the telecommunications system

Start programming mode: * (system PIN)

PRO

					Off		
					On		
Lift handset	Brokerage in the exch	Selection	Acknowledgement tone	Replace handset			

Continue programming or exit programming mode: *

END

Setting the flash time

Analog telephones with DTMF (dual tone multi-frequency dialling) require a flash key (R-key or signal key) among other things to transfer calls. You can adapt the telecommunications system to different flash times of the telephones. The flash time of your telephone is listed in the telephone's technical data.

Set the flash time at the terminal connection to which it is to apply.

As-delivered state: flash time – 50 to 600 ms

Proceed as follows on the telephone to test whether the set flash time is correct:

- set up external call
- press the Flash key
- the time is set correctly if you hear the internal dialling tone
- the connection is cut off, flash time in the telecommunications system is set too short.

Start programming mode: * (system PIN)

PRO

Lift handset	FLASH time	Input ID	Enter flash time range	Acknowledgement tone	Replace handset		
			2 = 50 to 200 ms				
			3 = 50 to 300 ms				
			4 = 50 to 400 ms				
			5 = 50 to 500 ms				
			6 = 50 to 600 ms				

Continue programming or exit programming mode: *

END

Programming Music on Hold

Define whether the held caller is to hear music on hold (MoH) when you make a refer back call or forward a call.

As-delivered state: Internal Music on Hold

You will hear 1 melodie in succession when you select the internal MoH.

Start programming mode: * (system PIN)

PRO

				Off		
				Internal MoH		
Lift handset	Music On Hold	Selection		Acknowledgement tone		Replace handset

Continue programming or exit programming mode: *

END

Sending zero

Terminals which support the CLIP function (phone number display) may have a call list. This allows simple dialling of unanswered calls. If you have switched off the external seizure "spontaneous

with internal" on this terminal, you have to switch on the "send zero" function.

As-delivered state: Send zero – off

Start programming mode: * (system PIN)

PRO

				Off		
				On		
Lift handset	Send zero	Selection		Acknowledgement tone		Replace handset

Continue programming or exit programming mode: *

END

P

CLIP function, set options

On analog terminals with caller number display (CLIP function) the TK system displays the caller number provided this transmitted by the caller or his network operator.

For the CLIP function, you may select one out of several options, given the terminal's support of the chosen option:

- display **name** of caller. The caller's name and number must be stored in the TK system phone book.
- display caller's number (**Phone number**)

- display **time and date**
- **Off** - no CLIP function for all subscribers

If you wish to set several options you have set each option individually, using procedur - * each time.

As-delivered state: caller number ON

In order to use the CLIP function you must switch the CLIP function on at the terminal (see operation - display caller number (CLPI)).

Start programming mode:  *    (system PIN)  

PRO

 Off

 Name

 Date/Time

 Phone number









Lift handset

Set CLIP option

Selection

Acknowledgement tone

Replace handset

Continue programming or exit programming mode:  *     

END

Protecting the programming mode and switch box against unauthorised access

You can prevent unauthorised access to the programming mode with a system PIN (**P**ersonal **I**dentify **N**umber).

You can prevent unauthorised access to the switch box by a box PIN.

System PIN – Normally every subscriber can program. With the 4-digit system PIN, you can prevent unauthorised starting of the programming mode. This protects your telecommunications system settings (e.g. authorisation of the internal subscribers) against unwanted changes. Programming is only possible when the system PIN has been entered after when the programming mode is started. You can switch the system PIN on or off or change it. In the **as-delivered state**, the system PIN is always 2580 (standard PIN), this is the middle keys from top to bottom. The standard PIN is switched off.

You can enter your own new PIN for better security.

The standard PIN or the new system PIN must be switched on and off separately.

If you forget your own system PIN you cannot do any more programming. In this case you will have to consult your dealer. Only he can reset the PIN.

Box PIN – You can dial the switch box of your telecommunications system en route from any telephone, e.g. to switch over the day/night service or set a diversion. You can protect the switch box against unauthorised access with the 4-digit box PIN. No box PIN is programmed in the **as-delivered state**. You have to enter a box PIN if you want to use the switch box.

Programming a system PIN

Start programming mode: (system PIN)

PRO

Lift handset	System pin	Selection	Enter new PIN	Enter PIN ID and 4-digit system PIN	Acknowledgement tone	Replace handset	

Continue programming or exit programming mode:

END

Enter system PIN?

If you hear the Acknowledgement tone after , the system PIN is switched off in the telecommunications system. There is no need to enter the system PIN.

If you do not hear any tone after , a system PIN is programmed in the

telecommunications system. Enter the 4-digit system PIN. You will hear the Acknowledgement tone if the PIN is correct. If the PIN is incorrect, you will hear the error tone (busy tone). Replace the handset and start the input again from the beginning.

Programming the box PIN (switch box PIN)

Start programming mode: * (system PIN) **PRO**

* Enter
 * Delete
 Lift handset **BOX** pin Selection Enter PIN ID and 4-digit switch box PIN Acknowledgement tone Replace handset

Continue programming or exit programming mode: * **END**

Entering the code

Enter your code (local network code). This saves you having to enter the code for phone numbers in the phonebook of your local network. The code is automatically prefixed to the transmitted phone number.

Start programming mode: * (system PIN) **PRO**

* Enter
 * Delete
 Lift handset Local code Selection Enter code ID and code number Acknowledgement tone Replace handset

Continue programming or exit programming mode: * **END**

Loading new firmware

You can update your AGFEO ISDN telecommunications system to the latest firmware state without manipulating the telecommunications system. You can load the new firmware with a PC at the PC interface or at the

USB interface of the telecommunications system. Your dealer can also load the new firmware in your telecommunications system remotely by ISDN.

Backing up the telecommunications system data

- Start the "TK-Set" configuration program on your PC.
- Read all the data from the telecommunications system (F8).
- Save the data on the hard disk or a diskette.
- Transfer the call data records with the "TK Bill" program if necessary.
- Save the LCR table.

Loading new firmware

- A firmware update consists of the files *xxx.abf* and *xxx.bin*. These files may be combined in a self-unpacking file (*xxx.exe*).
- The files *xxx.abf* and *xxx.bin* must be in the *Updates* directory of TK-Soft.
- (...)\tksoft\updates)
- Start the update program "TK-Flash"
- The online help will tell you how to operate "TK-Flash".

The new firmware is now loaded in the telecommunications system. You cannot use the telephone during the loading process (about 5 minutes). You can follow the loading progress on the PC monitor.

- Exit "TK-Flash".
- Clear the telecommunications system memory from the telephone.

Clearing the memory from the telephone

Start programming mode:      (system PIN)  

PRO



Lift handset



As-delivered state (clear memory)



Acknowledgement tone



Replace handset

The memories are cleared!

Loading telecommunications system data

Load the saved system data from the PC back into the telecommunications system.

The telecommunications system now operates with the new firmware.

Communication through PC

Software overview

The CD-ROM supplied contains the software package **TK-Soft** and the communications software **TK-Com**. The communications software makes available to you high-performance universal communications programs which give you the most important applications of data communication via the USB connection to the TK

system. For environmental reasons we have not provided large volumes of printed operating instructions for individual communication programs. You can access the help function for every application with key F1 and can print the help text out yourself if you wish.

Program components of software package TK-Soft

TK-Bill - is responsible for costing your calls. Provided your network operator transmits the tariff information, the software calculates all call costs. TK-Bill sorts and calculates by extension, date, call numbers or customers. It is also possible for all calls to be sorted by network provider. TK-Bill not only logs calls which incur costs but if requested will also log incoming calls, producing a logbook of all telephone activities.

TK-LCR - is a program aimed at reducing your telephone costs. Least-cost-routing means that you will always make calls using the cheapest provider. If the selected route happens to be busy the fallback function automatically switches to the next cheapest provider. This is implemented by an „intelligent“ database in table form. An individual routing table for cost-optimised calls can be created at any time. If for instance you wish only to call through providers who can be used without prior registration („Call-by-Call“) - no problem. Once you have entered this request you do not need to do anything else. The TK system will always search for the cheapest provider for any time and distance.

A weekly profile can be established for up to eight different providers with your network code. You can also freely specify eight tariff areas. Just click on the provider requested and drag it into the appropriate „timetable“ using the mouse - it's a simple as that !

It is even simpler if you use your dealer. He can enter the cheapest providers in your region into your TK system memory by remote configuration. Or you may for instance use the free tariff service on the internet and download your individual selection directly onto the PC.

TK-Phone - with the CTI program (computer telephone integration) the PC make calls via the TK system. It does not matter which program you are currently working in, TK-phone will inform you on the monitor at any time who is or was trying to call you. Simply double-click on the call list to return the call. Or you can immediately store all telephone numbers in the computer. The TK-Phone directory is limited only by the size of the hard disk. TK-Phone also allows you to select any telephone number on the screen: for example if you receive an e-mail and want to call the sender. Mark the phone number on the e-mail and copy the number into the temporary memory. Your phone rings. When you pick up, the number is dialled from the temporary memory. You can then speak to the subscriber.



TK-Set - for programming the TK system from a PC. Call diverting, ring sequences, daytime/night switching and all the parameters of the ISDN system can be quickly and easily set or modified. With TK-Set you can also store your individual configuration on the hard disk or diskette. If necessary you can transfer everything back to the TK system. [See chapter „Programming the TK system“].

C

TK-Info - is an information function which signals the current state of send or receive procedures on the windows task bar. The symbol in the task bar changes depending on the action. Further information is also displayed via a Tool tip.

TK-Fax - this application makes it possible for you to view and work on faxed documents both sent and received. Faxes are sent via the fax printer driver installed in the system; you can for instance print out the document to be faxed from your word-processing package via the fax printer driver.

The application shows all incoming and outgoing faxes in a log-book. It is possible to read and/or print out documents received and sent. To read a fax you highlight the document required in the log-book and open it through the Look function in the tool bar or the corresponding menu item in the Fax menu. If you want to look at various documents you do not need to open all the files individually; highlight all the corresponding documents and select the required function from the tool bar or the menus.

A document which has already been read will be marked  in the log-book. A short-cut print function assists in creating the log-book. Via the menu item Log-book- Print List the log-book selected will be printed. The symbols on the left-hand side make it possible to set filters for the log-book which the view will also follow. A document which has already been printed will be identified with the symbol  in the log-book. Transmission status is also shown in the log-book by various coloured arrows.

To delete log-book entries and the documents associated with them a button is available on the tool bar which when activated deletes all selected menu entries. You can also use the short-cut delete functions which you access via the menu item Delete in the log-book menu. However if you wish to delete log-book entries but not the faxes associated with them you can back-up documents via the disk symbol in the tool bar to your hard disk or other medium.

TK-File - this application makes it possible for you to exchange data quickly and easily with another user via the standardised Eurofile transfer. If you wish to transfer files you must first connect

to another PC. To do this enter a telephone number under Connection or select a number via the Combination field and activate the button Compile on the tool bar.

The presentation of files and navigation in the files takes place precisely as in Windows Explorer. On the left-hand side you will see the files which are on the hard disk. On the right-hand side the other user is shown in the same way. Highlight the files to be transferred and drag these with the mouse to the target file of the other computer.

TK-Tel - this application makes it possible to also use your PC conveniently as an ISDN telephone. TK-Tel contains the two program components AGFEO TK-Tel Telephone and AGFEO TK-Tel ControlCenter.

AGFEO TK-Tel Telefon contains the log-book, address books and configuration dialogs. All connections are logged in the log-book with important information.

The address books give you direct access to the databases which you have linked to these. For an incoming or outgoing telephone call you receive the necessary data for the relevant call directly.

The AGFEO TK-Tel ControlCenter appears as a telephone receiver in the taskbar of your system. Current connection data are displayed as a small window next to the Control Centre. Via this window you can select all connection-orientated functions with the mouse (eg hang up, swap broker, query). Via the menu functions you can perform all the necessary set and configure tasks for the application.

TK-Voice - is a convenient call-answering system on a software basis. This offers the user all the same functions as are offered by a conventional digital answering machine.

These include voice announcements, recording messages with date and time stamp and an integral remote access function.

As an option you can set a personal thirteen-digit remote access code. The increased code length offers a high level of security.

You need a telephone or full-duplex soundcard in addition to a microphone and loudspeaker though which you can record your personal announcement and listen to voice messages.

The program already contains pre-set announcements. You can listen to these announcements via the Announce button on the

toolbar or the corresponding menu item and modify them if you prefer a different message. Before you can listen to a message a call number must be defined.

Incoming messages will be displayed in a log-book. Via the symbols on the left-hand border you can select „display all messages“ or only new ones. The log-book printout will follow the selection made.

To listen to messages received you select this in the log-book and confirm using the Play button on the tool bar or select the corresponding menu

item in the Messages menu. The symbol  appears in the log-book against messages already listened to.

You can access a short-cut print function via the Print button or the corresponding menu item which assists you in printing out a log-book.

So that you do not waste valuable memory space on your hard disk, short-cut delete functions are available. Using the button Delete all the selected log-book entries and their corresponding sound files are deleted. If you want to take certain messages out of the log-book, however, but not finally delete them, you can back-up the file before deleting. You can back up the sound file on your hard disk or another medium via the menu item Store Under in the Messages menu.

WAN Miniport - is a driver for Windows 98 with which you can use the remote data transmission network via ISDN. You can make connections to the Internet using this and connect computers to one another (via the Remote Access Service). Further information on the remote data transmission network is available in Windows 98 documentation.

CTI - Computer-assisted calling via TAPI interface

TAPI - (Telephony Applications Programming Interface) in contrast to TK-Phone is not a stand-alone CTI application but an interface between a TAPI-compatible Windows application and the TK system. Provided programs (applications) support this interface, it is possible to control the TK system. The extent of control depends on the application used. However it usually includes starting outgoing calls (selection from the application) and display of incoming calls.

TAPI is a Microsoft Operating Systems interface and the application side of the Microsoft-Telephony-Interface. To connect this interface to the TK system a Telephony-Service-Provider (TSP) from the manufacturer of the ISDN hardware is necessary, in this case AGFEO. The TSP is a driver

which you must install on your PC. It executes the required TAPI functions and controls the necessary data exchange between the PC and the TK system.

Because of the continually growing function capability of TAPI-assisted applications the TSP needs to be continuously expanded. So that you always have the current TSP available we make the TSP available to you on our Internet homepage at <http://www.agfeo.de>.

The self-unpacking file contains all the information necessary for installation and for the applications supported. If you do not have internet access please contact your dealer. The TSP will be sent to you free of charge.

C

System requirements

The following are system requirements for installation of the software packages:

Desktop-PC or Notebook with hard disk and CD ROM

- . Pentium II or higher
- . RAM minimum 32 MB (more working memory improves performance)

- . 1 free USB interface
- Microsoft Windows 98/2000, ME,NT 4.0
- . Full-duplex soundcard, microphone and loudspeaker (optional) for TK-Voice (answering machine)

Set up USB connection

You can connect the TK system to a desktop PC or notebook via the USB interfaces.

1. Take the USB cable supplied (identified by the USB symbol on its plugs)
2. Plug the square plug [B-plug] for the USB cable into the USB socket on the TK system

3. Plug the flat plug [A-plug] on the USB cable into one of the USB connections on your computer
4. Switch your computer on.

When you first start up Windows with the TK system you will be asked to specify the position of the driver. For further details see section „Install driver software“.

Install driver software

Important ! If you have already installed an ISDN card from a different manufacturer in your computer you must first remove this. Follow the instructions in the manufacturer's handbook.

During the software installation, you are possibly requested to insert the operating system CD. Get your operating system CD.

Before you install the driver software the TK system must be connected to the PC via the USB interface.

1. When the PC has recognised the TK system connected to it the „Hardware Assistant“ appears. The Hardware Assistant installs the software for a new hardware component (AGFEO AC 14 USB). Click on „continue“.
2. In the next dialog window select „Look for the best driver for the equipment (recommended)“ and click on „continue“.
3. Activate the option „CD-ROM“ in the next dialog window and de-activate all other boxes. Place the CD in the CD-ROM slot and click on „continue“.

4. Once the drivers have been found, click on „continue“ to start installation.
5. The drivers will be installed.
6. Under "ISDN configuration" you read the note text and click on "continue".
7. Select the D-channel-protocol: "DSS!: Euro-ISDN" and click on "continue".
8. Now you are requested to input the telephone number(s). Enter the internal telephone number(s) for the PC at the USB link. The internal call numbers 20 to 29 are available (see system programming under port allocation). Click on "continue".
9. The ISDN configuration is finished. Click on "finish".
10. On request, insert the operating system CD, in order to load the USB support. After the software for the new device was installed, click on "finished".
11. Once installation is completed, start your PC up again.

If you want to modify the telephone number(s) for the PC in the USB link later:

Select " start / programs / accessories / communication / Assistant for ISDN configuration".

1. Under "ISDN configuration" you read the note text and click on "continue".
2. Select the D-channel-protocol: "DSS1: Euro ISDN" and click on "continue".
3. Now you are requested to input the telephone number(s). Enter the internal telephone

number(s) for the PC at the USB link. The internal call numbers 20 to 29 are available (see system programming under port allocation). Click on "finished".

4. The ISDN configuration is finished. Click on "continue".
5. For the termination of the installation you restart your PC.

Uninstall driver software

If at a later date you no longer want the driver software on your PC, you can uninstall this. Remove the AC 14 USB in the Device Manager

(find under System setup / System / Device Manager / Network cards / AGFEO ISDN AC 14 USB).

Install communications software

Before you start to install the communications software, close all open applications and make sure that the AC 14 USB is correctly installed.

Place the program CD in the CD slot. The installation program will be started automatically.

1. Select the communication software „TK-soft“ or „TK-com“ from the CD menu.
2. Click on the field „install“.
3. When requested, input the path and confirm. All the necessary files will now be copied automatically to the hard disk.

If the auto-start function is de-activated on your system, proceed as follows:

1. Open (double-click) the symbol „workplace“ on your desktop.
2. Open the symbol for your CD system.
3. Start the program setup.exe
4. Select the communication software „TK-soft“ or „TK-com“ from the CD menu.
5. Click on the field „install“.
6. When requested, input the path and confirm. All the necessary files will now be copied automatically to the hard disk.

C

Connections to Internet or other network

These instructions show you how to connect to the Internet or other network with the Microsoft remote data transmission network.

1. Open (double-click) the symbol „workplace“ on the desktop.
2. Open (double-click) the symbol „DT network“. The DT network is automatically installed as standard in Windows 98. If the remote data transmission network does not appear under „workplace“, you can still install it. Select „Start / setup / system control / software“. Further information can be found in the Windows Help index under „Software, install components“.
3. If this is the first connection, click on „continue“. Otherwise open (double-click) „Create new connection“.
4. In Help enter a name for the connection eg the name of your provider.
5. Under „Select device“ select „AGFWMP-Line 1“ and click on „continue“.
6. Enter the ISDN dialling number for your Internet provider or the remote network and click on „continue“.
7. Click on „complete“. A symbol for this connection will appear.

Configure connection

1. If the remote data transmission network is not open: Open (double-click) the symbol „workplace“ on the desktop. Open (double-click) the symbol „remote data transmission network“.
2. Open the dialog window in which you can configure your connection. Click with the right mouse key on the symbol for the previously installed connection and select „Properties“.
3. Activate the registration card „Server types“. Execute the following steps:
 - If you are setting up an Internet connection, deactivate „Register with network“.
 - Activate „software compression“.
 - For connections to the Internet activate only „TCP/IP“ as the protocol.

Dialling the Internet or other network

Once you have set up the connection to your internet provider or the network as described you can now dial into the corresponding network. If you want to surf the net or access your e-mail you must have a web browser or e-mail application installed.

To connect, follow these steps:

1. Open (double-click) the symbol „workplace“ on the desktop.
2. Open (double-click) the symbol „remote data transmission network“.
3. Open (double-click) the symbol for the connection set up previously
4. In the dialog window „connect to“ do the following:
Input the name made available by your internet provider and the code word.
Click on „connect“.
As soon as the connection is made the dialog window „connected to“ appears.
5. You can now surf the internet with your web browser or access your e-mails with an e-mail application.

Disconnecting

To disconnect click on the dialog window „connected to“ on „disconnect“.

If this window has minimised to a symbol, click on the symbol in the task bar.

Glossary

Services

A service identification (ID) (e.g. telephony, fax) is transmitted in ISDN when an ISDN subscriber is called. The caller is only connected if the called terminal has the same service ID. This prevents wrong connections of two different terminal types (e.g. phone and fax).

DT - network

With the Microsoft Windows data transmission network your computer can accept a connection to an internet service provider.

Terminals

Appliances which you connect as internal subscribers of the telecommunications system. Analog terminals such as telephones, answering machines, fax machines, combi-devices (telephone, fax and possibly answering machine in one unit), modem.

External

A distinction is made between internal and external calls when telephoning in a telecommunications system. External calls are calls to subscribers which are not connected to your telecommunications system. Connections between terminals of your telecommunications system and other terminals at your multi-equipment access are therefore also external connections. The local tariff is usually charged for such connections.

External seizure (seize outside line)

Seizure of a line (B-channel) to call an external subscriber.

Outgoing external connection

Connection to an external subscriber set up from a terminal of the telecommunications system by dialling an external phone number.

Pulse dialling method (PD)

Every dialled digit is assigned a fixed number of pauses. The pauses are audible in the earphone when dialling.

Internal

Internal calls are calls which subscribers in the telecommunication system hold with each other by dialling the internal phone number. These calls are generally free.

ISDN (Integrated Services Digital Network)

All services (speech and data) can now be transmitted in one network.

Incoming external connection

Connection to a terminal of the telecommunications system set up by an external subscriber with the phone number of the telecommunications system.

Configuration

Setting (programming) the functions of the telecommunications system with a PC by means of a configuration program.

Line (B-channel/S0 basic access)

You can connect an external S0 basic access to your ISDN telecommunications system. Every external S0 basic access behaves like two conventional analog lines. You therefore have two lines (B-channels) on which you can make telephone calls (local, long distance or overseas calls).

Dual tone multi-frequency dialling method (DTMF)

Every dialled digit is assigned a certain tone. Telephones with this dialling method require a signal key (refer back key R) on the telecommunications system.

MoH (Music on Hold)

A waiting external subscriber hears music whilst the connection is on hold, e.g. when a call is forwarded.

MSN (Multiple Subscriber Number)

The multiple subscriber number is one of the phone numbers under which the multi-equipment access can be reached.

NTBA (Network Termination for ISDN Basic Access)

The network operator lays his copper cables up to this access point (S0 basic access). You connect your telecommunications system and other ISDN terminals to it.

Ringling assignment

In the ringling assignment you define which terminals of the telecommunications system are to ring when an external call is received. Should only one terminal ring or several terminals simultaneously?

Ringing assignments for external calls are: day service, night service and forwarding (internal). You can switch over between day and night service at any time from any telephone. Internal call forwarding – An incoming external call which is not answered within a certain time is forwarded. The terminals of the telecommunications system defined in the call forwarding then ring. The number of rings until forwarding is adjustable.

Switch box

You can call the switch box of your telecommunications system externally and for example switch the ringing assignment, set up a diversion or monitor a room with a post-dialled * procedure.

You can reach the switch box externally by a multiple subscriber number (MSN) specially assigned to the switch box. The switch box is protected against unauthorised access by the box PIN.

Signal key R (refer back)

A key on the telephone which you have to press when you want to refer back to another subscriber during a call. The signal key must have the flash function, i.e. must be able to effect a short pause.

USB

Universal **S**erial **B**us is a serial interface with transmission rate up to 12 Mbit/s. A USB connection can serve several items of equipment simultaneously. These can be added or removed during the current operation.

If something goes wrong







Inspections

- In the case of malfunctions in the telecommunications system, please check the system is being operated correctly as described in the operating instructions.
 - Check that the connections of the terminals and the telecommunications system are correctly plugged in.
 - If you cannot eliminate a fault, your dealer will be glad to help.
- N. B.! You can only use the ISDN features of your AGFEO ISDN telecommunications system if your network operator provides these features.

Switching off the special dialling tone

You hear the special dialling tone when you lift your telephone's handset. You hear the special dialling tone when do not disturb, automatic dialling or a diversion are active.

You can deactivate all functions which initiate a special dialling tone with the * procedure.

						
Lift handset	Special dialling tone (deactivate functions)				Acknowledgement tone	Replace handset

Power failure

You cannot dial internally or externally during a power failure.

- callbacks are deleted
- the connections parked in the telecommunications system are deleted
- the connection cost totals and connection data records are saved.

When power supply is recovered:

- the telecommunications system works again with the previously configured program. All the settings made by the programming mode or the PC program are retained providing the programming mode was properly terminated.

Behaviour in the event of faults

Fault	Possible causes	Remedy
Programming of telecommunications system unclear		Reset the telecommunications system Reset the telecommunications system to the as-delivered state and reprogram
No dialling tone on lifting the handset	Power failure	Check mains connection, fuses
	Defective terminal	Check terminal at another connection
	Defective installation	Check the terminals in the socket and on the telecommunications system
No internal calls are received	Do not disturb switched on (special dialling tone)	Switch off do not disturb
	Diversion to another telephone (internal/external) (special dialling tone)	Switch off diversion
No external calls are received	Wrong MSN entered	Enter right MSN, delete all if necessary
	MSN – internal subscriber assignment missing	Assign internal subscriber to the MSN (ringing assignment)
	Do not disturb switched on (special dialling tone)	Switch off do not disturb
	Diversion to another telephone (internal/external) (special dialling tone)	Switch off diversion
	ISDN call forwarding is active	Deactivate ISDN call forwarding
No outgoing external connection possible	No authorisation programmed	Check authorisation, access to ISDN network, assignment of barred numbers
	Cost limit reached	Inform system administrator
Transfer of external call (refer back) not possible	The refer back key Γ on the telephone is set as an earth key	Set the telephone to DTMF (tone dialling) and the refer back key to flash
	Incorrect flash time	Set the flash time on the telephone or on the telecommunications system for the terminal connection concerned

Resetting the telecommunications system

You can return the programming of the telecommunications system to a defined condition by resetting. This may be necessary when unclear settings are to be reset or the telecommunications system is to be re-programmed.

After the reset, the telecommunications system operates again with the previously configured program. All the settings made by the programming mode or the PC program are retained providing the programming mode was terminated properly.

Attention! The following are deleted when the telecommunications system is reset:

- all existing internal and external connections
- remote configuration
- internal callbacks
- ISDN callback on busy
- Line reservations







Hardware reset – Pull the power pack from the socket of the 230 V mains and plug it back in.

Software reset – Run the following procedure

Software reset

Start programming mode:      (system PIN) 

PRO

     

Lift handset **RES**et the telecommunications system Replace handset

Rings

External call

All ringing rhythms for incoming external calls start with an initial ringing of 500 ms. This is followed by a 2 s pause. This is for technical reasons to transmit the caller's phone number (CLIP). It is then possible to distinguish calls under different phone numbers of the telecommunications system (see diagram).

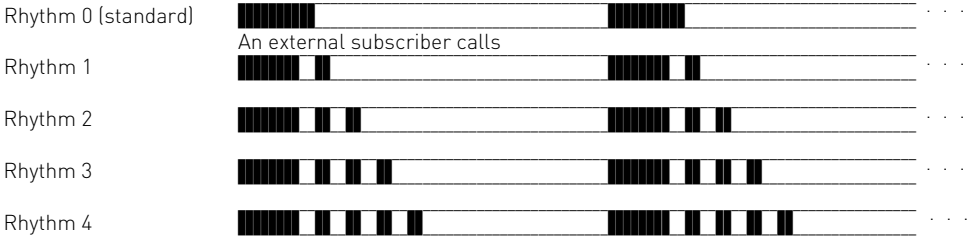

Internal call



Reserving a line



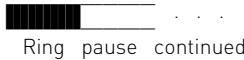

Explanation:





The rings may deviate depending on the terminal used.

Tones

Dialling tone

- internal  signals that you can dial after lifting the handset
- external  continuous tone which you hear when you have seized a line after dialling "0"

Ringing tone

- internal  The internal subscriber is called
- external  The external subscriber is called

Busy tone

-  The dialled internal or external subscriber is busy

Special dialling tones

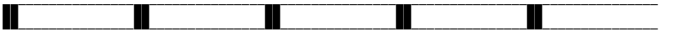
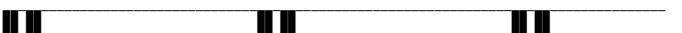
-  Signals, after lifting the handset, that you can dial but do not disturb, automatic dialling or a diversion is switched on
- Programming tone  Signals, after lifting the handset, that you cannot dial, the programming mode or the cost menu are switched on
- Lock tone  Signals, after lifting the handset, that the telephone is locked.

Knocking tone

-  Signals an external call in your conversation after 10 s

Acknowledgement tone

-  Input accepted

Error tone

-  Operating error/input rejected

Explanation:

-  tone pause continued

Technical data

Housing dimensions	15.4 x 21.5 x 4.6 (width x height x depth) in cm
Weight	980 g including power pack
Ambient temperature - operation/storage	5 °C to 40 °C/-25 °C to +70 °C
Humidity	max. 70% (no condensation)
Main connection - power consumption at $U_{\text{rated}} = 230 \text{ V}$ and full load - length of the connecting cable - power pack (type)	230 VAC, +10%/-10%, 50 Hz $I_{\text{rated}} = 40 \text{ mA}$ (9 VA) 2 m TST 433238
S0 access - connection - length IAE cable	Multi-equipment access, Euro ISDN by Western socket RJ45 and enclosed IAE connecting cable IAE8/IAE8 1.5 m
Analog terminals - range - connection - dialling method - refer back key - Modem operation	4 a/b terminals (telephone, answering machine, fax, modem) 2 x 50 ohms (\varnothing 0.6 mm, 800 m) symmetrical, 2-wire via TASE connections without coding F or N or via screw terminals, plug-in Pulse dialling or DTMF Flash (50 to 200 ms) transmission speed up to 56600bps, can be reduced if necessary to 33600 bps by transmission path and lines
PC interface - range - connection - length of the PC cable	similar to RS 232C 3 m, +/-5 V 9-pole D-Sub socket 2m
USB interface - length of the USB cable	Universal Serial Bus 3 m
Data backup during power failure	unlimited
Music on Hold (MoH)	internal, 1 melodie

Key words

A

Acknowledgement tone	A - 5
Analog terminals	I - 4, S - 2
Answering calls	O - 3
Answering machine. <i>Siehe</i> TK-Voice	
Picking up a call	O - 11
Assigning the barred numbers	P - 8, P - 11
Asterisk key	I - 4, O - 3
Authorisation	O - 3
access to the ISDN network	P - 8
defining	P - 9

B

B-channel. <i>See</i> Line	O - 6
Barred numbers	
assigning	P - 11
programming	P - 10
Barred range	O - 3
Basic factor	O - 25
Box PIN	O - 8, P - 17, A - 2
programming	P - 18
Brokerage	O - 16
Setting a variant	P - 14
Busy LED	I - 5, S - 1
Busy on busy	O - 7
Busy tone	A - 5

C

Callback	O - 5, O - 16
internal	O - 17
on busy	O - 17
Calling an internal subscriber	O - 2
Calling external subscribers	O - 2
Callthrough one the move	O - 9
Charge pulses	O - 25
Clearing the memory	P - 4
CLIP function, set options	P - 16
Combi-device	P - 11
Combi-device connection	O - 2
Communication of the charge pulses	O - 25
Communication software. <i>Siehe</i> TK-Com, TK-Soft	
Communication through PC	C - 1
Conference	O - 11
Connecting the PC	P - 1
Connecting the telecommunications system	S - 3
Connection assignment	S - 4
PC cable	P - 1
Connection costs	O - 1, O - 2, O - 25
Connection ID	O - 14
Connection panel	S - 1
opening and closing	S - 4
Connections to Internet or other network	C - 6

Cost menu	O - 25
Cost PIN	O - 25
CTI - Computer-assisted calling	C - 3

D

Data transmission	I - 4
Day service	
programming	P - 5
switching on	O - 12
Defining ringing assignment	P - 5
Dialling method	I - 4, S - 2, A - 1
Dialling tone	A - 5
Direct call	O - 18
Display charges for the last call	O - 28
Diversion	O - 23
activating (switching on)	O - 24
deactivating (switching off)	O - 24
via the ISDN exchange	O - 23
via the telephone system	O - 23
Diversion from	O - 10
Do not disturb	O - 18
DT network	C - 6, A - 1
DTMF post-dialling	O - 3
Dual tone multi-frequency dialling method (DTMF)	I - 4, A - 1
Durchrufen von unterwegs	O - 9

E

END (exit programming mode)	P - 4
Entering terminal types	P - 11
Entering the code	P - 18
Entering the limit	O - 26, P - 12
Error tone	A - 5
ESC (old settings)	P - 4
Eurofiletransfer. <i>Siehe hier</i> TK-File	
External	A - 1
External call	A - 4
External connection	
incoming	A - 1
outgoing	A - 1
External seizure	O - 2, A - 1
at combi-device connection	O - 2
spontaneous	O - 1
spontaneous with internal	O - 1
switching	O - 1
with "0"	O - 2
with certain MSN	O - 2

F

Fallback	O - 12
Fault	A - 2
Fax	P - 11. <i>Siehe</i> TK-Fax
Follow me (diversion from)	O - 10

K

Forwarding (internal)	
Cycles (ringing cycles)	P - 7
Programming	P - 5
Free range	P - 10
Function LED	I - 5, S - 1

H

Hash key	I - 4
Having a caller identified	O - 7

I

Incoming external connection	A - 1
Input in the programming mode	P - 3
Inspections in the event of malfunctions	A - 2
Install communications software	C - 5
Install driver software	C - 4
Installing the configuration program	P - 1
Interface	
RS 232C	S - 4
Internal	A - 1
Internal call	A - 4
Internal phone numbers	P - 5
Internet	C - 6
ISDN	A - 1
access (S0)	S - 1, S - 2
bus	S - 2
call forwarding	O - 23
callback on busy	O - 17
connecting cable	S - 3
hold	P - 14
malicious call tracing	O - 7
parking (replugging on the bus)	O - 13
sockets	S - 2
terminals	S - 2
transmitting the phone number	O - 21

K

Keys	I - 5
Knocking	O - 3
answer call	O - 3
reject	O - 4
Knocking prevention	O - 4
Knocking tone	O - 3, A - 5
KOS (start cost menu)	O - 26

L

Least Cost Routing (LCR)	O - 12
Light emitting diodes (LED)	I - 5
Busy LED (red)	I - 5
Function LED (green)	I - 5
Limit/Disconnect at limit	O - 25
Line	O - 1, A - 1
List of contents	I - 3
Loading new firmware	P - 19
Local network code	P - 18

Lock	O - 18
Locking/unlocking the telephone	O - 18

M

Malfunctions	A - 2
Malicious call tracing	O - 7
Minimum PC requirements	P - 1
Modem	I - 4, P - 11
MSN (Multiple Subscriber Number)	A - 1
Multi-equipment access	S - 2
Multiple subscriber numbers (MSN)	
quick entry	S - 3
save	S - 3, P - 5
Music on Hold (MoH)	A - 1
Muting	O - 16

N

Network code	O - 12
Network provider	O - 12
Night service	O - 12
programming	P - 15
NTBA (NT) – network termination	S - 2

O

Outgoing external connection	A - 1
------------------------------	-------

P

Parking	
in the ISDN exchange	O - 13
in the telephone system	O - 13
PC interface	S - 1, S - 4
Phonebook	
Dialling the phone number	O - 20
Programming the phone number	O - 19
Pick up. <i>Siehe</i> Anrufe heranholen	
Picking up a call	O - 10
Pictograms	I - 5
PIN (Personal Identity Number)	
Box PIN	O - 8
Cost PIN	O - 25
System PIN	P - 17
Telephone PIN	O - 18
Post dialling	O - 3
Post dialling numbers	O - 3
Power failure	A - 2
Power pack	
connecting	
Power pack	
connecting	
Power	
connecting	S - 3
Power supply	S - 2
PRO (start programming mode)	P - 3
Program components in the communication software	
	C - 2

Program components of software	C - 1	System PIN	
Programming		entering	P - 3, P - 17
with a PC	P - 1	programming	P - 17
with a telephone	P - 3	System requirements	C - 4
Programming mode		T	
exit	P - 4	TAPI interface	C - 3
start	P - 3	Tariff unit	O - 25
Programming regional numbers	P - 10	Technical data	A - 6
Programming short commands	P - 12	Telefax. <i>Siehe</i> TK-Fax	
Pulse dialling method	I - 4, A - 1	Telephone	P - 11
R		Telephone line	S - 4
Refer back	O - 16	Telephone PIN	O - 18
in the room	O - 16	Telephoning	
Remote configuration – Remote service		Calling externally	O - 2
Release	P - 2	Calling internally	O - 2
Remote service phone number	P - 2	Terminals	A - 1
Remote control (switch box)	O - 8	Analog	I - 4
Reserving a line	O - 2, A - 4	Connecting to external TAE sockets	S - 4
Resetting the telecommunications system	A - 4	Connecting to the telecommunications system	S - 2
Restoring old settings	P - 4	Flash time	S - 2, P - 14
Restoring the as-delivered state	P - 4	Types	S - 2, P - 11
Ring assignment	O - 12, A - 1	Three-party conference	O - 11
Ringling rhythms	A - 4	Timer	O - 21
setting	P - 7	TK-Com	
Ringling tone	A - 5	TK-Fax	C - 2
Rings	A - 4	TK-File	C - 2
Room monitoring	O - 15	TK-Info	C - 2
RS 232C interface	S - 4	TK-Tel	C - 2
		TK-Voice	C - 2
S		TK-Soft	
S0 basic access	A - 1	TK-Bill	C - 1
Safety Instructions	I - 4	TK-LCR	C - 1
Scope of delivery	S - 1	TK-Phone	C - 1
Selecting location	S - 1	TK-Set	C - 1
Send zero	P - 15	Tones	A - 5
Service ID	P - 11	Tracing – identifying malicious callers	O - 7
Services	A - 1	Transferring a call	O - 5
Set up USB connection	C - 4	Internal	O - 5
Setting external calls	P - 7	Transmitting the phone number	O - 1, O - 2
Setting list of callers	P - 13	Switching	O - 21
Setting the call list	P - 13	Transmitting your phone number	O - 1, O - 2, O - 21
Setting the flash time	P - 14	TSP	C - 3
Short dialling index	O - 19	U	
Signal key R (refer back)	I - 4, A - 2	USB connection	C - 4
Software. <i>Siehe</i> Firmware		USB-interface	S - 4
Software overview	C - 1	User factor	O - 25
Soundcard	C - 4	W	
Special dialling tone	O - 6, O - 10, O - 18, A - 5	Wall mounting	S - 3
ISDN exchange	O - 24	Western plug	S - 3
switching off	A - 2		
Standard PIN	P - 17		
Switch box	O - 8, P - 6, A - 2		
Box PIN	P - 17, A - 2		
Phone number	P - 6		

Copyright

Copyright 2000 AGFEO GmbH & Co. KG
Gaswerkstr. 8
D-33647 Bielefeld

We reserve all rights to this documentation; this applies especially in the event of a patent award or registered utility.

The documentation may not be changed or translated manually or in any other way into any

language or computer language of any form by any means neither wholly nor in part without our express permission. This applies for electronic, mechanical, optical, chemical and all other media.

Trade marks and names used in this documentation are subject to the rights of the companies concerned.

Technical modifications

The AGFEO GmbH & Co. KG reserves the right to change representations and data in this documentation in the interests of technical progress without prior notice.

This documentation has been prepared with the utmost care and is revised regularly. Despite all our care, however, technical inaccuracies and typographical errors cannot be totally ruled out. All errors which become known to us will be corrected in new editions. We are grateful for any hints at errors in this documentation.

You can only use the numerous ISDN features of your AGFEO ISDN telecommunications system if your network operator offers them.

Technical hotline

If you have any questions concerning operation of your telecommunications system which these operating instructions cannot answer, please consult your dealer.

Before calling your dealer you should have the following information ready to save time:

- What kind of telecommunications system do you have?
e.g. AGFEO AC 14 USB (is printed on the rating plate on the system)
- What multiple subscriber numbers (MSN) have you got?
(is on the registration form or confirmation of the network operator)
- What software version is on your AGFEO installation diskettes? (printed on the diskettes)
- What software version does your telecommunications system have?
(can be read out on the PC)
- What terminals have you connected to your telecommunications system? (analog terminals with an without DTMF dialling, fax machines etc.)
- Keep the operating instructions of the connected terminals and this manual ready.
- Start your PC and read out the configuration with TK-Set. Print out the configuration of your telecommunications system if possible.

Konformitätserklärung

Declaration of Conformity
Déclaration de Conformité

Der Hersteller: AGFEO GMBH & Co. KG
The Manufacturer:
Le Constructeur:

Adresse: Gaswerk Str. 8
Adress: D - 33647 Bielefeld
Adresse:

Erklärt, dass das Produkt: AC 14 WebPhonie
Declares that the Product:
Déclare que le Produit::

die grundlegenden Anforderungen gemäß Artikel 3 der nachstehenden EU-Richtlinien erfüllt:
meets the essential requirements according to article 3 of the following EC-Directive:
est conforme aux exigences essentielles d' article 3 de la Directive CE:

Richtlinie 1999/5/EG des Europäischen Parlaments und des Rates vom 09. März 1999
über Funkanlagen und Telekommunikationsendeinrichtungen und die gegenseitige
Anerkennung ihrer Konformität

Directive 1999/5/EC of the European Parliament and of the Council of 09 March 1999 relating to
radio and telecommunications terminal equipment, including the mutual recognition of their
conformity
Directive 1999/5/CE du Parlement européen et du Conseil du 09 mars 1999 concernant les radio
et équipement terminaux de télécommunications, incluant la reconnaissance mutuelle de leur
conformité

und dass die folgenden harmonisierten Normen angewandt wurden:
and that the following harmonised standards has been applied:
et que les standards harmonisés suivants ont été appliqués:

EN 60950/1997

EN 55022/1998

EN 55024/1998

TBR3 Anhang 1/Dez. 1997

Schicht 1-3

Bielefeld, 07. September 2000

Ort und Datum der Konformitätserklärung
Place and date of the declaration
Lieu et date de la déclaration

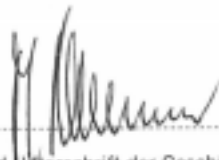
Name und Unterschrift der Geschäftsleitung
Name and Signature
Nom et Signature

K



This device meets the requirements of the EU directives:
91/263/EWG Telecommunications Equipment
73/23/EWG Low voltage equipment
89/336/EWG Electromagnetic compatibility
Your telephone carries the CE mark of approval.

Ident. No. 538 477
Subject to modifications.
Printed in Germany
1001

AGFEO GmbH & Co. KG
Gaswerkstr. 8
D-33647 Bielefeld
Internet: <http://www.agfeo.de>